

**artinox<sup>®</sup>**

PORTUGUESE LIGHTING SINCE 1977



**artinox**<sup>®</sup>  
PORTUGUESE LIGHTING SINCE 1977

**artinox**<sup>®</sup>  
PORTUGUESE LIGHTING SINCE 1977

### EMPRESA

A Artinox é uma empresa certificada que garante aos seus clientes a qualidade dos seus produtos e a eficiência dos seus processos, com uma vasta gama de soluções de iluminação.

Desde 1977, a Artinox tem vindo a desenvolver e produzindo soluções de iluminação decorativa, integrando a vanguarda das tecnologias e materiais de alta qualidade nos seus produtos assim como excelentes acabamentos.

A Artinox possui uma equipa jovem e dinâmica com grande capacidade e know-how, com uma área produtiva de mais do que 6.000 m2 e aproximadamente 67 funcionários, localizados no Município de Águeda. Pesquisando e desenvolvendo novos produtos, onde usa as mais modernas técnicas industriais.

A qualidade dos nossos produtos, a capacidade de resposta e versatilidade, juntamente com o estrito cumprimento de nossos compromissos com os nossos clientes, permitiu-nos estabelecer e crescer nos vários mercados internacionais, com um aumento constante e sustentado das nossas exportações, em mercados como a Alemanha, França, Noruega, Suécia, Irlanda, Países Baixos, Áustria, Bélgica, Rússia, Reino Unido, Espanha, Norte de África e Dubai.

### ENTREPRISE

ARTINOX est une entreprise certifiée qui garantit à ses clients la qualité de ses produits et l'efficacité de ses processus, avec une vaste collection de solutions d'éclairage.

Depuis 1977, ARTINOX développe et fabrique des solutions d'éclairage décoratif, en intégrant dans leurs produits, des technologies de pointe et des matériaux de haute qualité avec une excellente finition.

Avec une superficie de production supérieure à 6.000 m2 et 67 employés, situé dans la municipalité de Águeda, ARTINOX dispose d'une équipe jeune et dynamique avec une grande habileté et de savoir-faire. Toujours à la recherche de développement de nouveaux produits, en utilisant des techniques indu elles les plus modernes.

La qualité de nos produits, la réactivité et la polyvalence, couplé avec le strict respect des engagements avec nos clients nous a permis nous a permis d'établir et de se développer dans les différents marchés internationaux, avec une croissance constante et soutenue de nos exportations, qui atteignent plus de 60% de nos chiffres d'affaires, étant nos principaux marchés l'Allemagne, la France, la Norvège, la Suède, l'Irlande, les Pays-Bas, Autriche, Belgique, Russie, Royaume-Uni, l'Espagne, l'Afrique du Nord et Dubai.



### COMPANY

Artinox is a certified company that guarantees its customers the quality of its products and the efficiency of its processes, with a vast collection of lighting solutions.

Since 1977, Artinox has been developing and producing decorative lighting solutions, integrating cutting edge technologies and high quality materials into its products with excellent finishes.

Artinox has a young and dynamic team with great capacity and know-how, with a productive area of more than 6.000 m2 and 67 employees, located in the Municipality of Águeda. Researching and developing new products, where it uses the most modern industrial techniques.

The quality of our products, the responsiveness and versatility, coupled with the strict compliance with our commitments to our customers, has enabled us to establish and grow in the various international markets, with a constant and sustained increase in our exports, which reach Germany, France, Norway, Sweden, Ireland, the Netherlands, Austria, Belgium, Russia, UK, Spain, North Africa and Dubai.



## ARTINOX, uma empresa certificada pela APCER.

**ARTINOX, a company certified by APCER.**  
**ARTINOX, société certifiée par APCER.**

A Artinox é uma empresa certificada pela ISO 9001, que atesta a qualidade de seus processos e produtos através do seguinte:

.Padronização de todos os processos chave da empresa,

.Monitoramento e medição de processos de fabricação para garantir a qualidade do produto e serviço;

.Implementação e manutenção de registros adequados e necessários para garantir a rastreabilidade do processo;

.Inspeção de qualidade e meios adequados de ação corretiva quando necessário;

.Revisão sistemática de processos e sistema de qualidade.

Artinox is a ISO 9001 certified company, which attests to the quality of its processes and products through:

.Standardization of all key company processes,

.Monitoring and measurement of manufacturing processes in order to ensure the quality of the product and service;

.Implementation and maintenance of adequate and necessary records to guarantee the traceability of the process;

.Quality inspection and appropriate means of corrective action when necessary;

.Systematic review of processes and the quality system.

Artinox est une société certifiée ISO 9001, qui atteste de la qualité de ses processus et produits à travers:

.De la standardisation de tous les processus clés de l'entreprise,

.De la surveillance et gestion des processus de fabrication afin d'assurer la qualité du produit et du service;

.Mise en place et maintenance de dossiers adéquats et nécessaires pour garantir la traçabilité du processus;

.L'inspection de la qualité et les moyens appropriés d'action corrective si nécessaire;

.Revue systématique des processus et du système de qualité.



### Responsabilidade ambiental

A Artinox S.A. destaca-se em políticas e práticas de respeito ambiental e sustentabilidade. Este compromisso estende-se a todos os processos de fabricação e na escolha dos nossos parceiros para as diferentes áreas de negócios.

De forma a contribuir para a proteção ambiental, a harmonia total entre os diferentes componentes de negócios (económicos, sociais e ambientais), a Artinox SA estabelece o monitoramento e controle do consumo de matérias-primas, perfil de energia, emissões de gases poluentes na atmosfera e de resíduos inerentes para a indústria, como uma prioridade no nosso processo de fabricação.

### Environmental responsibility

Artinox S.A. excels in policies and practices of environmental respect and sustainability. This commitment extends to all manufacturing processes and the choice of our partners for different business areas.

In order to contribute to environmental protection, in total harmony between the different business components (economic, social and environmental), Artinox SA establishes the monitoring and control of raw material consumption, energy profile, emissions of pollutant gases into the atmosphere and of waste inherent to industry, as a priority for our manufacturing process.

### Responsabilité environnementale

Artinox S.A. se distingue dans les politiques et pratiques de respect de l'environnement et du développement durable. Cet engagement s'étend à tous les processus de fabrication et au choix de nos partenaires pour différents domaines d'activité.

Afin de contribuer à la protection de l'environnement, en totale harmonie entre les différentes composantes économiques, sociales et environnementales, Artinox SA établit le suivi et le contrôle de la consommation de matières premières, du profil énergétique, des émissions de gaz polluants dans l'atmosphère et des déchets inhérents à l'industrie, comme une priorité pour notre processus de fabrication.

## INDEX

### COLEÇÕES

COLLECTIONS . COLLECTIONS

<b>medusa</b> p . 26	ross p . 30	<b>dumont</b> p . 32	halm p . 34	<b>pivot</b> p . 36	twist p . 38	<b>ascot</b> p . 40	gravity p . 42	<b>armour</b> p . 44	job p . 46	<b>fun</b> p . 48	willy p . 50	<b>ovline</b> p . 52	she p . 54
<b>rise</b> p . 56	big round p . 58	<b>big square</b> p . 62	woody mix p . 66	<b>arch</b> p . 68	quadra p . 70	<b>recta</b> p . 72	round p . 74	<b>cris</b> p . 76	cone p . 78	<b>bridge</b> p . 80	loft p . 82		

### APLIQUES

WALL LIGHTS . APPLIQUES MURALES

**apliques** . wall lights . appliques murales  
p . 86

**luzes de leitura** . reading lights . liseuses  
p . 98

**ilumina quadros** . picture lights . appliques pour tableau  
p . 114

**sinalética** . signaletic . signalisation  
p . 118

### SUSPENSÕES / CANDEIROS DE TETO

SUSPENSIONS / CEILING LAMPS . SUSPENSIONS / LAMPES SUSPENDUES

**teto** . ceiling . lampes suspendues  
p . 126

**plafond** . plafond . plafonnier  
p . 160

### CANDEIROS DE MESA

TABLE LAMPS . LAMPES DE TABLE

p . 162

### CANDEIROS DE PÉ

FLOOR LAMPS . LAMPADAIRES

p . 174

### CERÂMICA E VIDRO

CERAMIC AND GLASS . CÉRAMIQUE ET VERRE

**cerâmica** . ceramic . céramique  
p . 190

**vidro** . glass . verre  
p . 194

### DOWNLIGHTS & SPOTLIGHTS

DOWNLIGHTS & SPOTLIGHTS / DOWNLIGHTS & SPOTLIGHTS

p . 202

### HERITAGE

HERITAGE . HERITAGE

p . 212

## INDEX



### **CASA DE BANHO**

**BATHROOM . SALLE DE BAIN**

espelhos . mirrors . miroirs

p . 230

apliques . wall lights . appliques murales

p . 242

plafond . plafond . plafonnier

p . 248



### **ABAJURES**

**SHADES . ABAT-JOUR**

p . 250



### **ACABAMENTOS**

**FINISHINGS . FINITIONS**

p . 254



### **INFO. TÉCNICA**

**TECHNICAL INFO. . INFO. TECHCNIQUE**

p . 258

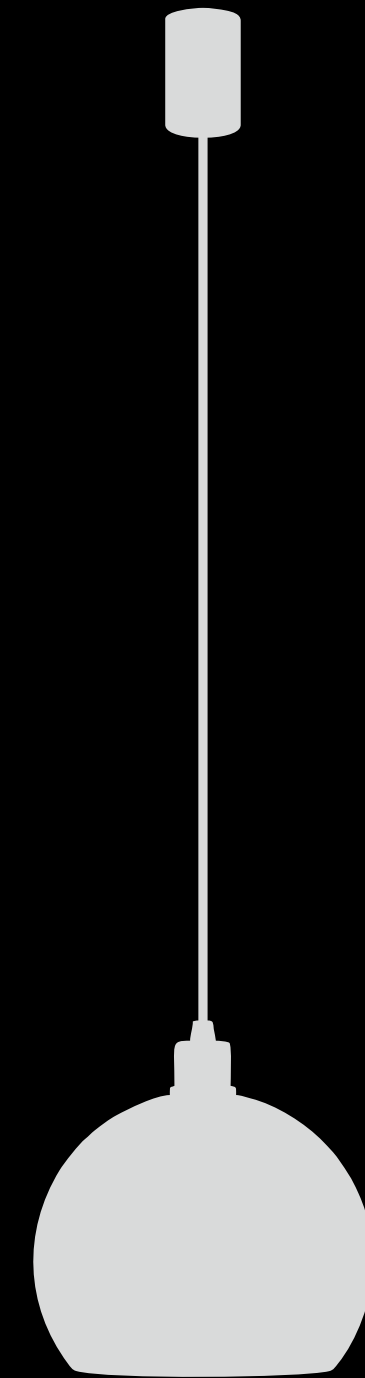

## **ÍNDICE DE PRODUTO**

**PRODUCT INDEX . INDEX DES PRODUITS**

# COLEÇÕES

COLLECTIONS . COLLECTIONS

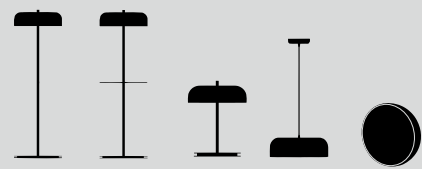

**MEDUSA**  
pag 27

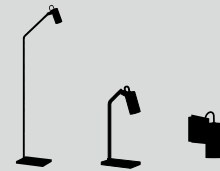

**ROSS**  
pag 31

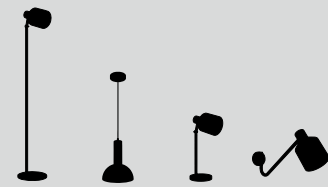

**DUMONT**  
pag 33

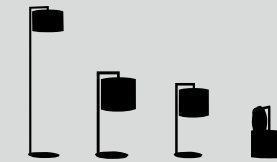

**OVLINE**  
pag 53

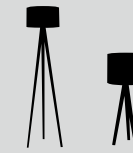

**SHE**  
pag 55

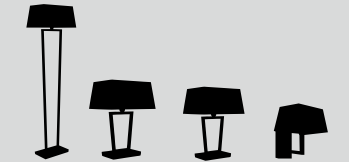

**RISE**  
pag 57

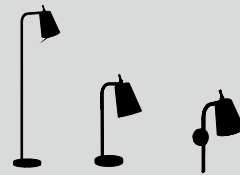

**HALM**  
pag 35

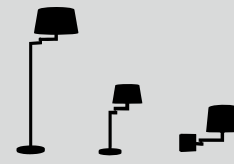

**PIVOT**  
pag 37

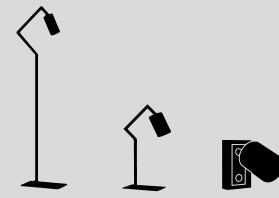

**IWISI**  
pag 39

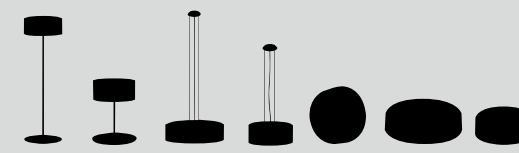

**BIG ROUND**  
pag 59

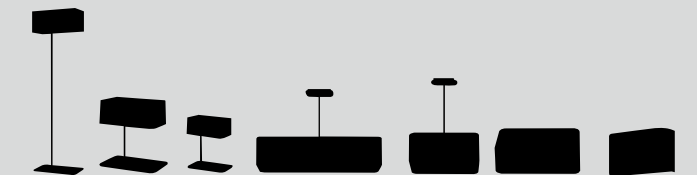

**BIG SQUARE**  
pag 63

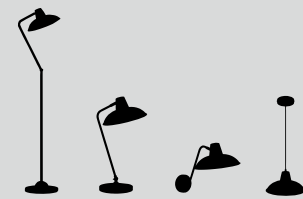

**ASCOT**  
pag 41

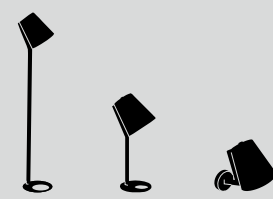

**GRAVITY**  
pag 43

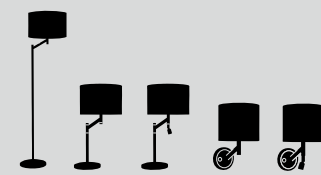

**ARMOUR**  
pag 45

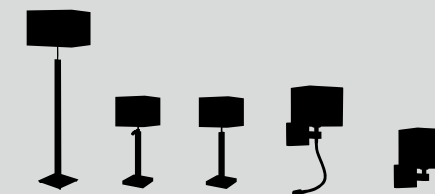

**WOODY MIX**  
pag 67

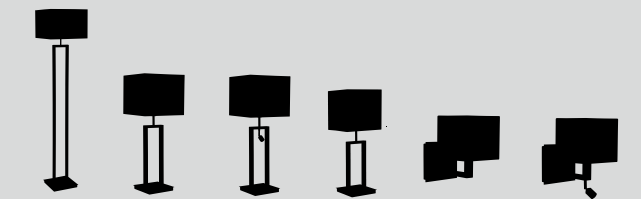

**ARCH**  
pag 69

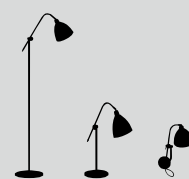

**JOB**  
pag 47

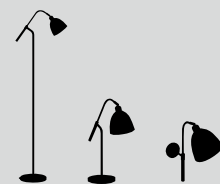

**FUN**  
pag 49

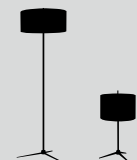

**WILLY**  
pag 51

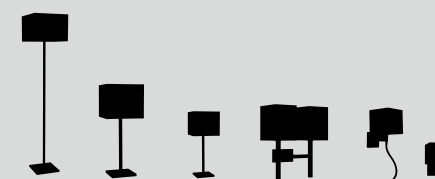

**QUADRA**  
pag 71

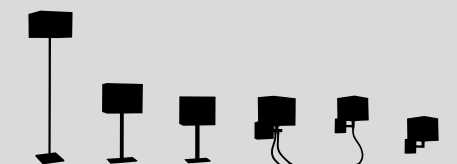

**RECTA**  
pag 73



## APLIQUES

WALL LIGHTS . APPLIQUES MURALES

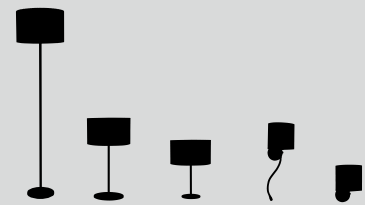

**ROUND**  
pag 75

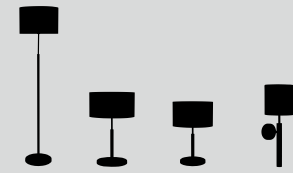

**CRIS**  
pag 77

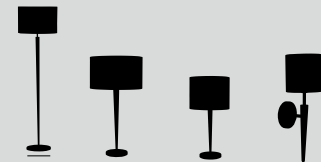

**CONE**  
pag 79

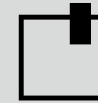

**ZANZI**  
pag 87



**ZANZI**  
pag 87

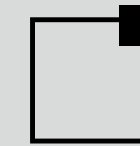

**ZANZI**  
pag 87



**JAVA**  
pag 89



**KOBE**  
pag 91



**RIO**  
pag 93

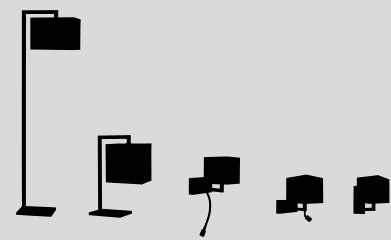

**BRIDGE**  
pag 81

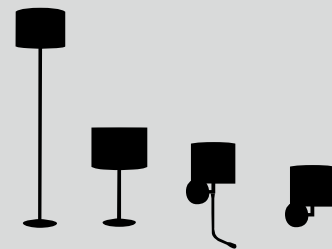

**LOFT**  
pag 83



**RIO**  
pag 93



**RIO**  
pag 93



**NICO**  
pag 95



**PAUL**  
pag 95



**KUBE**  
pag 96



**KUBE**  
pag 96



**NOVA**  
pag 97



**NOVA**  
pag 97

## LUZES DE LEITURA

READING LIGHTS . LISEUSES

## ILUMINA QUADROS

PICTURE LIGHTS . APPLIQUES POUR TABLEAU



**VICTORIA**  
pag 100



**ELIZABETH**  
pag 101



**TILE**  
pag 103



**UNO**  
pag 103



**SEA**  
pag 103



**HAURA**  
pag 105



**LOUIS I**  
pag 116



**BASEL**  
pag 116



**LOUIS II**  
pag 117



**LOUIS III**  
pag 117



**LOUIS IV**  
pag 117



**KANDY**  
pag 107



**KANDY RECESS**  
pag 107



**SNAKE**  
pag 108



**SNAKE**  
pag 108



**LASKA**  
pag 109



**AGRA**  
pag 109



**AGRA**  
pag 109

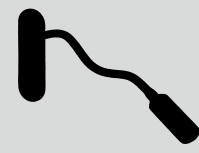

**FLEX**  
pag 111



**FLEX**  
pag 111

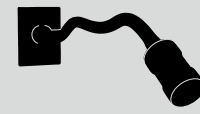

**FLEX**  
pag 111



**BED**  
pag 112



**BED**  
pag 112



**ACRA**  
pag 121



**ACRA**  
pag 121



**AP-1186/06**  
pag 123



**AP-1185/20**  
pag 123

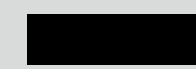

**AP-1184/21**  
pag 123

## SINALÉTICA

SIGNALETIC . SIGNALISATION



**BED**  
pag 112



**FLEX**  
pag 113



**FLEX**  
pag 113



**FLEX**  
pag 113



**FLEX**  
pag 113

# SUSPENSÕES / CANDEIROS DE TETO

SUSPENSIONS / CEILING LAMPS . SUSPENSIONS / LAMPES SUSPENDUES

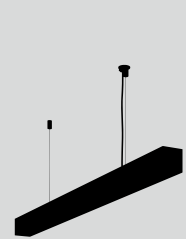

**DARIO**  
pag 127

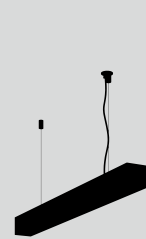

**DARIO**  
pag 127

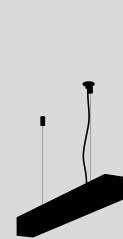

**DARIO**  
pag 127

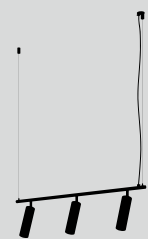

**CHICAGO**  
pag 129



**SANTA**  
pag 131

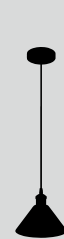

**SANTA**  
pag 131

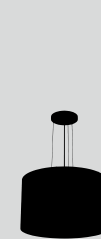

**LUCAS**  
pag 150



**MASTI**  
pag 151

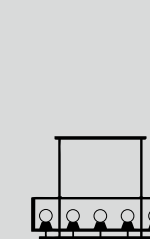

**OLIMPUZ**  
pag 153

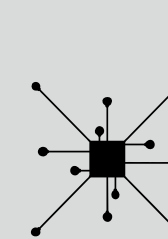

**ROOTS**  
pag 155

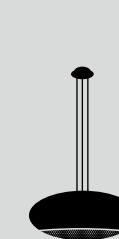

**MOON**  
pag 157



**CLUSTER**  
pag 158



**SANTA**  
pag 131



**SANTA**  
pag 131



**BALTI**  
pag 133



**GRAND BALTI**  
pag 133

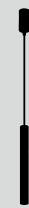

**SNOW ROUND**  
pag 135



**SNOW GRAND ROUND**  
pag 135



**BEGOOD**  
pag 159



**AZORES SQUARE**  
pag 161



**AZORES ROUND**  
pag 161

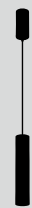

**SNOW SQUARE**  
pag 135



**SNOW GRAND SQUARE**  
pag 135

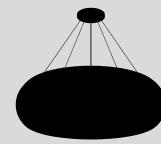

**CORK**  
pag 137

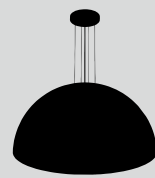

**DIVA**  
pag 139



**HOOK**  
pag 141

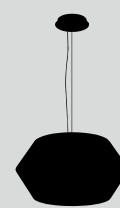

**SIERRA**  
pag 143

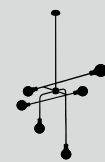

**MIRO**  
pag 145

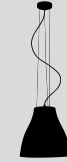

**BELL**  
pag 147



**SONG**  
pag 148



**KINGS**  
pag 148

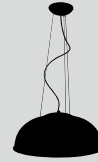

**SONG**  
pag 149



**KINGS**  
pag 149

## CANDEIROS DE MESA

TABLE LAMPS . LAMPES DE TABLE



**CANYON**  
pag 165



**KARA**  
pag 167



**NICO**  
pag 167



**BERLIN**  
pag 167



**OSLO**  
pag 168



**TOKIO**  
pag 168

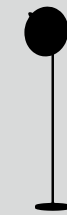

**SIRIUS**  
pag 177



**SIRIUS**  
pag 177



**HAVANA**  
pag 179



**PALM**  
pag 181



**HOME**  
pag 183



**MUTENE**  
pag 185



**RIVO**  
pag 168

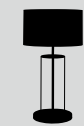

**JAR**  
pag 169



**MUTENE**  
pag 169



**CRANE**  
pag 171



**URBAN**  
pag 171

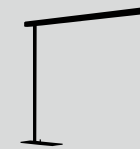

**BP55**  
pag 171



**MUTENE**  
pag 185



**POWEEL**  
pag 187



**ARTUS**  
pag 187



**BASEL**  
pag 173



**BASEL**  
pag 173

## CANDEIROS DE PÉ

FLOOR LAMPS . LAMPADAIRES

## CERÂMICA

CERAMIC . CÉRAMIQUE



**ORNI**  
pag 191

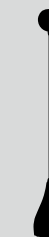

**ORNI**  
pag 191



**ORNI**  
pag 193

**VIDRO**  
GLASS . VERRE



**BIG GROOVE**  
pag 195



**SMALL GROOVE**  
pag 195



**NIGHT I**  
pag 197



**NIGHT II**  
pag 197



**COSMO**  
pag 210

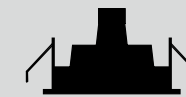

**LUAN**  
pag 211



**NIGHT III**  
pag 198



**NIGHT I**  
pag 199



**NIGHT II**  
pag 199



**NIGHT III**  
pag 199



**MALI**  
pag 201



**MALI**  
pag 201

**HERITAGE**  
HERITAGE . HERITAGE

**DOWNLIGHTS & SPOTLIGHTS**

DOWNLIGHTS & SPOTLIGHTS . DOWNLIGHTS & SPOTLIGHTS



**PAUL LANTERNS**  
pag 214



**MING LANTERNS**  
pag 215

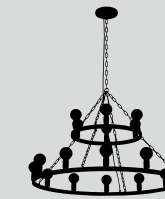

**JAVA TWO ROUNDS**  
pag 217

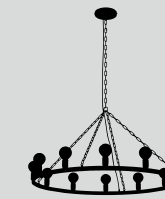

**JAVA ONE ROUND**  
pag 218

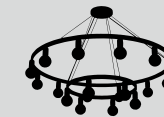

**JAVA DOWN TWO ROUNDS**  
pag 219



**DUTCH**  
pag 221



**SPY**  
pag 205



**RABIA**  
pag 207



**RABIA ROUND TRIPLE**  
pag 207

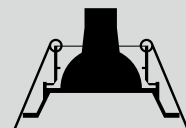

**ZIP IP65**  
pag 208



**ZIP**  
pag 209



**COSMO**  
pag 210



**DUTCH**  
pag 223



**DUTCH**  
pag 224



**DUTCH**  
pag 225



**DUTCH**  
pag 226



**AUGUST**  
pag 227

## CASA DE BANHO

BATHROOM . SALLE DE BAIN

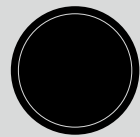

**KATE**  
pag 230



**MAKEUP MIRROR**  
pag 231

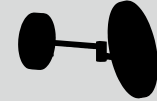

**MAKEUP MIRROR**  
pag 231

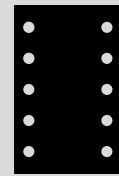

**HOLLYWOOD**  
pag 233

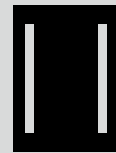

**PHARMACY**  
pag 235

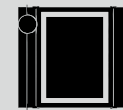

**WAY**  
pag 237



**PORTO**  
pag 248



**PORTO**  
pag 248

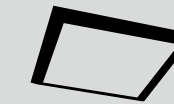

**PORTO**  
pag 248



**AVEIRO**  
pag 249



**AVEIRO**  
pag 249



**AVEIRO**  
pag 249

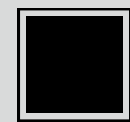

**BASS**  
pag 237



**KOE**  
pag 239



**FAIR**  
pag 240

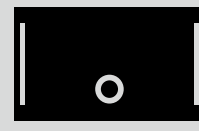

**JUNO**  
pag 240



**ESPERANCE**  
pag 240



**AQUA**  
pag 240



**LISBOA**  
pag 249



**LISBOA**  
pag 249



**LISBOA**  
pag 249



**LISBOA**  
pag 249

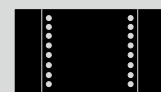

**ROBERT**  
pag 241



**CRISTAL**  
pag 241



**ANA**  
pag 241

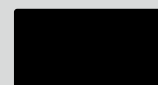

**KRIS**  
pag 241

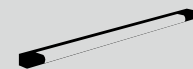

**CHITA ROUND**  
pag 243

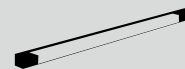

**CHITA SQUARE**  
pag 243



**GALIA**  
pag 245



**GULF**  
pag 245

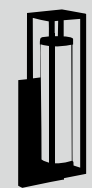

**JARA**  
pag 247



**JARA**  
pag 247



**PORTO**  
pag 248



**COLEÇÕES**  
COLLECTIONS . COLLECTIONS

medusa . ross . dumont . halm . pivot . twist . ascot . gravity . armour . job . fun . willy . ovlone . she . rise . big  
round . big square . woody mix . arch . quadra . recta . round . cris . cone . bridge . loft



**MEDUSA**

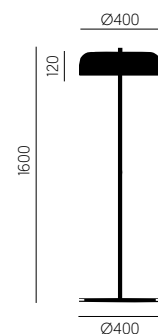

**CP - 1040**

2x E27 - MAX. 60W  
 230V/150Hz

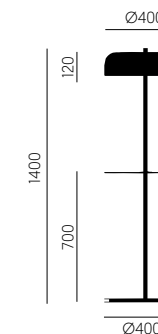

**CP - 1041**

2x E27 - MAX. 60W  
 230V/150Hz



**preto texturado / oxidado**  
 textured black / antique gold  
 noir granit / or antique

mais acabamentos sob consulta . more finishes on request . plus finitions sur demande p. 255





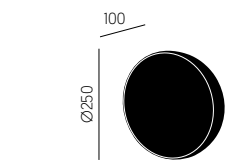

## MEDUSA

**AP - 1334**

2x G9 - MAX. 25W  
 IP20 CE 230V 1.50Hz

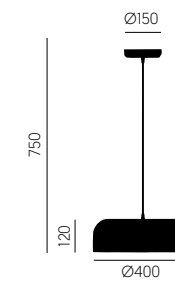
**SU - 0960**

2x G9 - MAX. 25W  
 IP20 CE 230V 1.50Hz

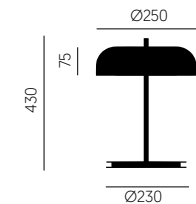
**CM - 0484**

2x E14 - MAX. 40W  
 IP20 CE 230V 1.50Hz



 **preto texturado / oxidado**  
 textured black / antique gold  
 noir granit / or antique

mais acabamentos sob consulta . more finishes on request . plus finitions sur demande p. 255



ROSS

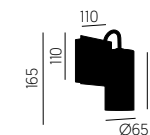
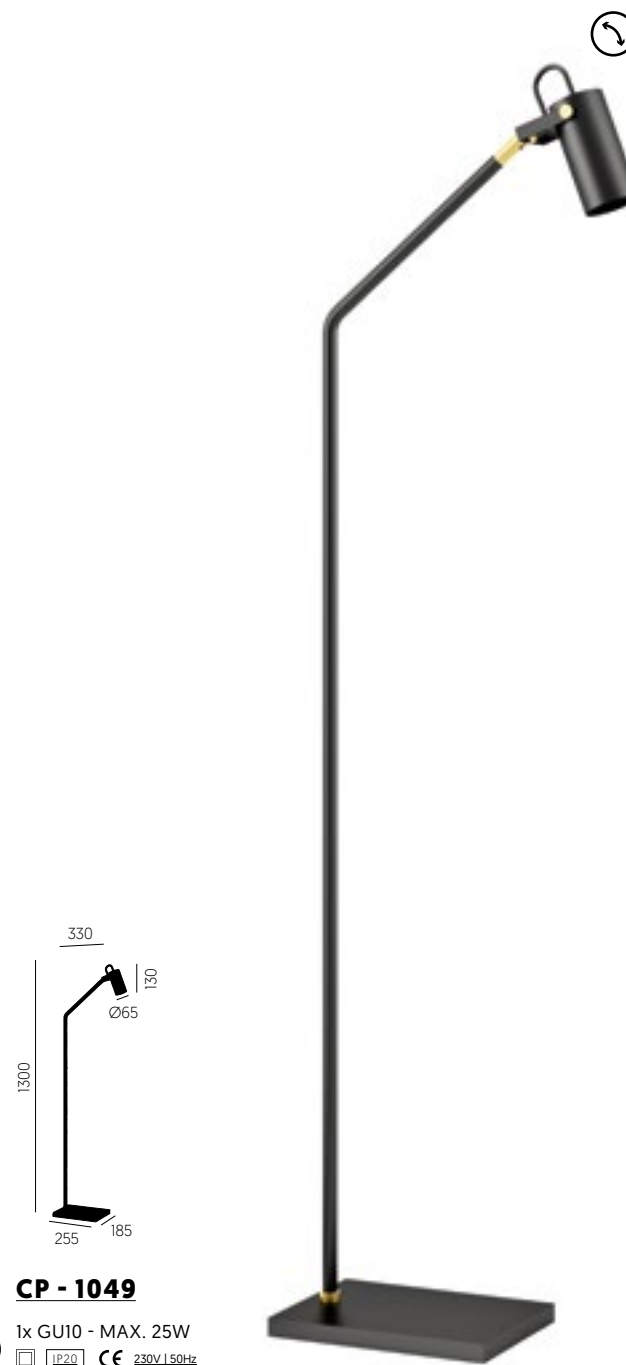

**AP - 1347**

1x GU10 - MAX. 25W  
 IP20 CE 230V | 50Hz

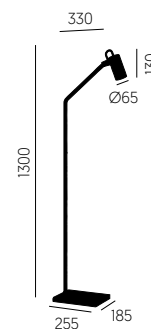

**CP - 1049**

1x GU10 - MAX. 25W  
 IP20 CE 230V | 50Hz

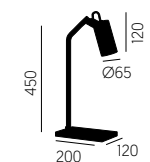

**CM - 0491**

1x GU10 - MAX. 25W  
 IP20 CE 230V | 50Hz



 **preto mate / oxidado**  
 matte black / antique gold  
 noir mat / or antique

mais acabamentos sob consulta . more finishes on request . plus finitions sur demande p. 255

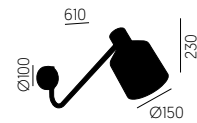
**AP - 1348**

1x E27 - MAX. 40W  
 230V/1.50Hz

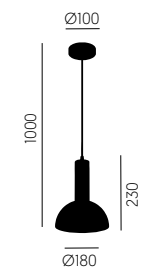
**SU - 0961**

1x E27 - MAX. 60W  
 230V/1.50Hz

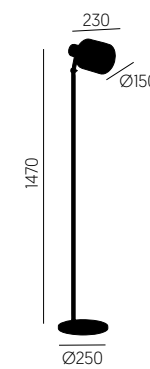
**DUMONT****CP - 1050**

1x E27 - MAX. 60W  
 230V/1.50Hz

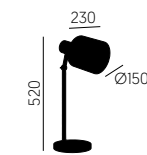
**CM - 0492**

1x E27 - MAX. 60W  
 230V/1.50Hz





## HALM



**preto brilhante**  
glossy black  
noir brillant

mais acabamentos sob consulta . more finishes on request . plus finitions sur demande p. 255

**chintz branco**  
white chintz  
chintz blanc

consultar . check . consulter p. 251



**PIVOT**

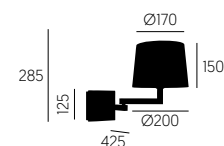

**AP - 1350**

1x E27 - MÁX. 40W  
 IP20 CE 230V.150Hz



**AP - 1351**

1x E27 - MÁX. 40W  
 IP20 CE 230V.150Hz

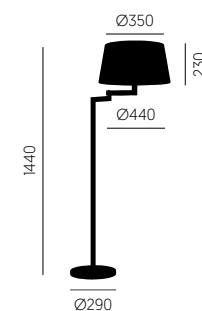

**CP - 1052**

1x E27 - MÁX. 60W  
 IP20 CE 230V.150Hz

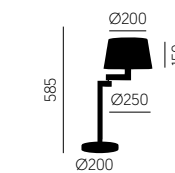

**CM - 0494**

1x E27 - MÁX. 60W  
 IP20 CE 230V.150Hz



**cromado**  
 chrome  
 chrome poli

mais acabamentos sob consulta . more finishes on request . plus finitions sur demande p. 255



**chintz branco**  
 white chintz  
 chintz blanc

consultar . check . consulter p. 251



TWIST



ARTINOX PORTUGUESE LIGHTING SINCE 1977

**TWIST**



**CP - 1044**  
 1x E27 - MAX. 60W  
 IP20 CE 230V/1.50Hz

**AP - 1336**  
 1x GU10 - MAX. 25W  
 IP20 CE 230V/1.50Hz

**CM - 0486**  
 1x E14 - MAX. 40W  
 IP20 CE 230V/1.50Hz

**preto brilhante / cobre brilhante**  
 glossy black / glossy copper  
 noir brillant / cuivre brillant  
 mais acabamentos sob consulta . more finishes on request . plus finitions sur demande p. 255





ASCOT

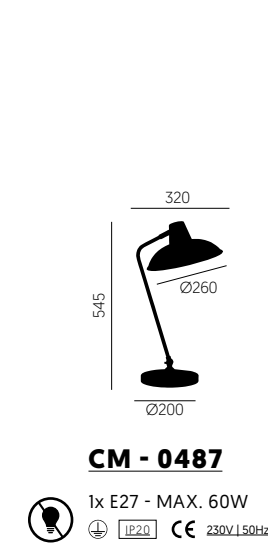
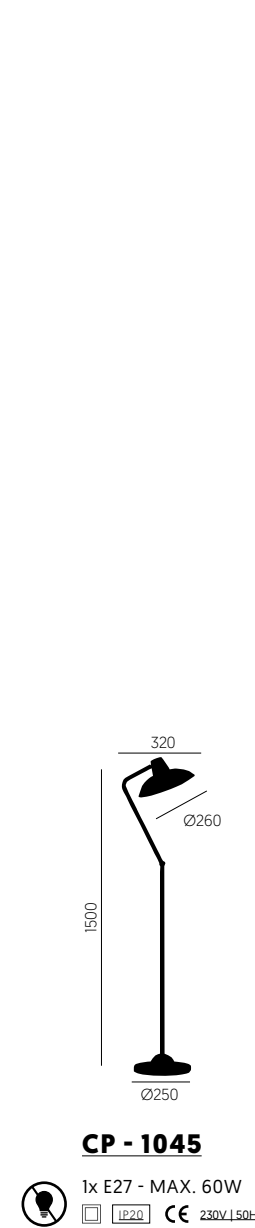
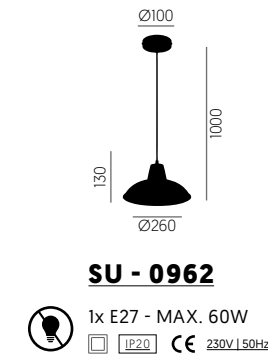
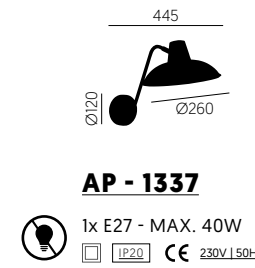

oxidado / bege brilhante (ral 3012)  
antique gold / glossy beige (ral 3012)  
or antique / beige brilhante (ral 3012)

mais acabamentos sob consulta . more finishes on request . plus finitions sur demande p. 255



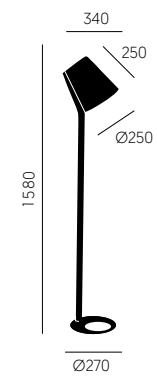

## GRAVITY

**CP - 1053**

1x E27 - MAX. 60W  
  230V/50Hz

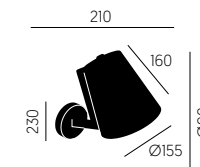
**AP - 1338/17**

1x E27 - MAX. 40W  
  230V/50Hz

**Left Side Version (AP-1338/16)**

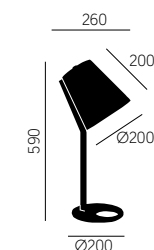
**CM - 0495**

1x E27 - MAX. 60W  
  230V/50Hz



 **vermelho ral 3003 / cinza ral 7016 / cromado**  
 red ral 3003 / grey ral 7016 / chrome  
 rouge 3003 / gris 7016 / chrome poli

**mais acabamentos sob consulta** · more finishes on request · plus finitions sur demande p. 255





ARMOUR

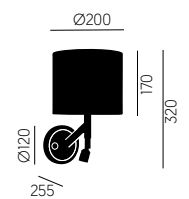

**AP - 1339/17**

1x E27 - MAX. 40W  
 1x LED - MAX. 3W  
 3000°K 190lm  
 Driver included  
 IP20 CE 230V.150Hz

Left Side Version [AP-1339/16]

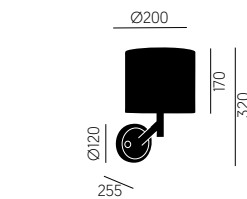

**AP - 1340/17**

1x E27 - MAX. 40W  
 IP20 CE 230V.150Hz

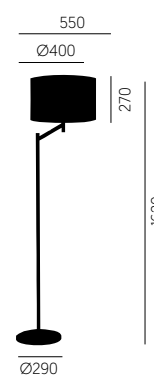

**CP - 1047**

1x E27 - MAX. 60W  
 IP20 CE 230V.150Hz

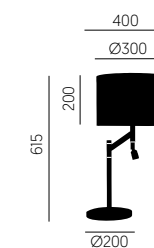

**CM - 0490**

1x E27 - MAX. 60W  
 1x LED - MAX. 3W  
 3000°K 190lm  
 Driver included  
 IP20 CE 230V.150Hz

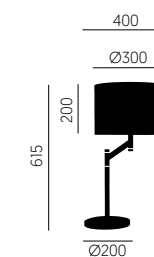

**CM - 0489**

1x E27 - MAX. 60W  
 IP20 CE 230V.150Hz



preto mate / oxidado  
 matte black / antique gold  
 noir mat / or antique

mais acabamentos sob consulta . more finishes on request . plus finitions sur demande p. 255

chintz preto  
 black chintz  
 chintz noir

consultar . check . consulter p. 251





**JOB**

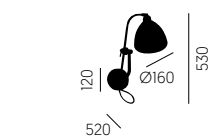

**AP - 1302**

1x E27 - MAX. 40W  
 IP20 CE 230V 150Hz

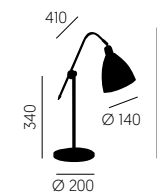

**CM - 0461**

1x E27 - MAX. 60W  
 IP20 CE 230V 150Hz

**níquel escovado / vermelho**  
 brushed nickel / red  
 nickel brossé / rouge

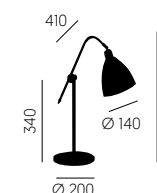

**CM - 0461**

1x E27 - MAX. 60W  
 IP20 CE 230V 150Hz

**latão polido / branco mate**  
 polished brass / matte white  
 laiton poli / blanc mat

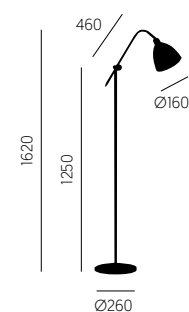

**CP - 1023**

1x E27 - MAX. 60W  
 IP20 CE 230V 150Hz

**cromado / preto mate**  
 chrome / matte black  
 chrome poli / noir mat

mais acabamentos sob consulta . more finishes on request . plus finitions sur demande p. 255

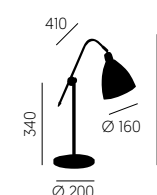
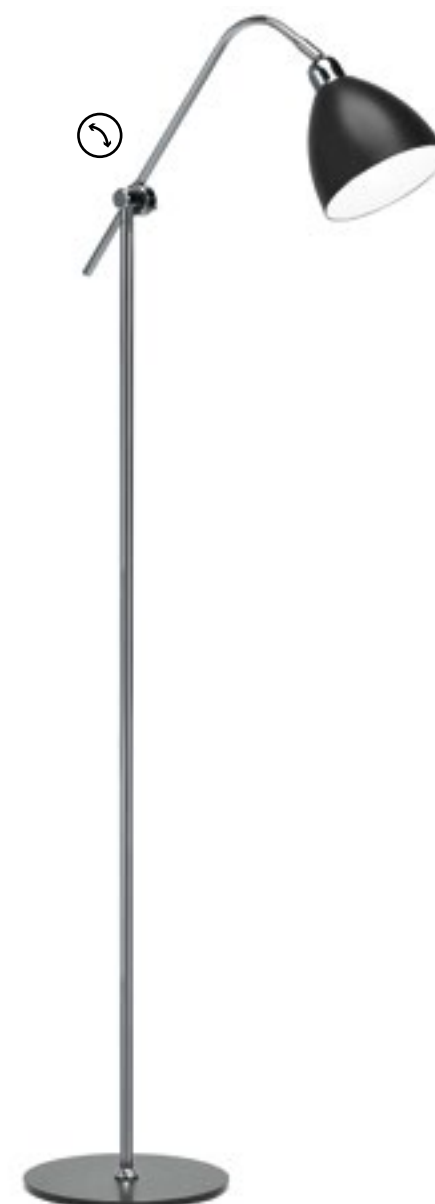

**CM - 0461**

1x E27 - MAX. 60W  
 IP20 CE 230V 150Hz

**Cromado / preto mate**  
 chrome / matte black  
 chrome poli / noir mat





**FUN**

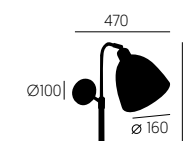
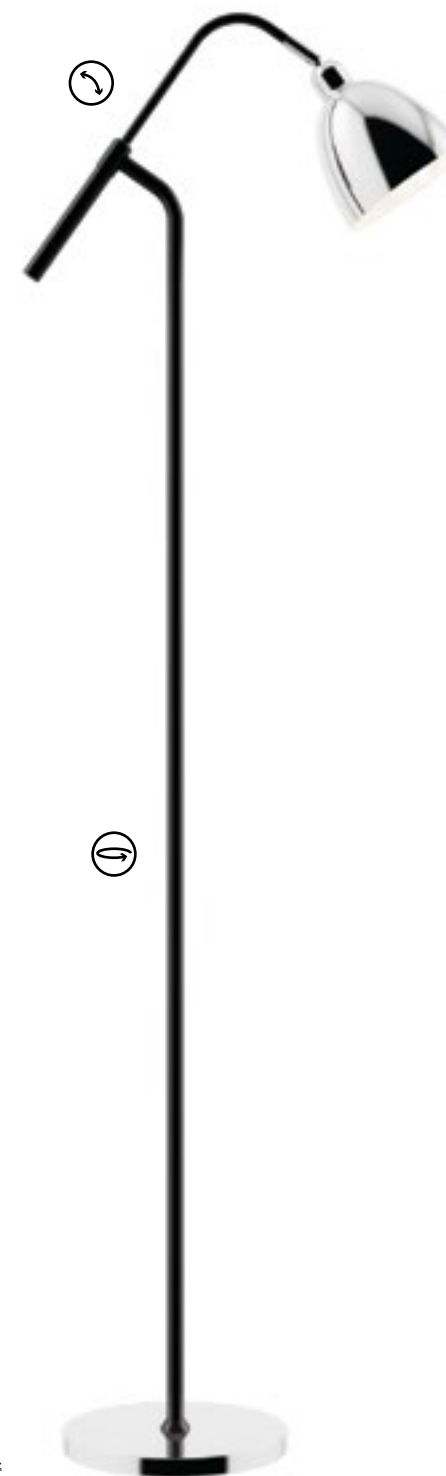

**AP - 1321**

1x E27 - MAX. 40W  
 IP20 CE 230V/1.50Hz

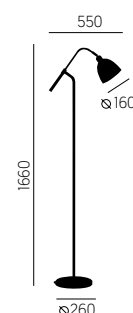

**CP - 1035**

1x E27 - MAX. 60W  
 IP20 CE 230V/1.50Hz

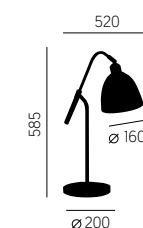

**CM - 0476**

1x E27 - MAX. 60W  
 IP20 CE 230V/1.50Hz



**cromado / preto mate**  
 chrome / matte black  
 chrome poli / noir mat

mais acabamentos sob consulta . more finishes on request . plus finitions sur demande p. 255





WILLY

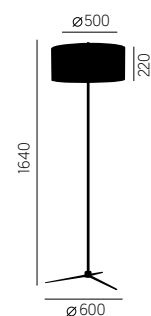

CP - 1024

2x E27 - MAX. 60W  
 230V/1.50Hz

**cromado**  
 chrome  
 chrome poli

mais acabamentos sob consulta . more finishes on request . plus finitions sur demande p. 255

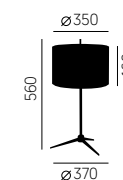

CM - 0462

2x E27 - MAX. 60W  
 230V/1.50Hz

**chintz branco**  
 white chintz  
 chintz blanc

consultar . check . consulter p. 251





OVLINE

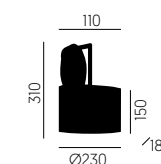

**AP - 1305**

1x E27 - MAX. 40W  
 IP20 CE 230V/150Hz

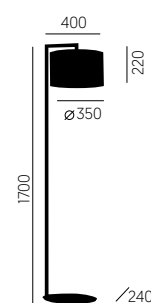

**CP - 1027**

1x E27 - MAX. 60W  
 IP20 CE 230V/150Hz

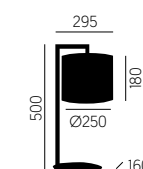

**CM - 0465**

1x E27 - MAX. 60W  
 IP20 CE 230V/150Hz

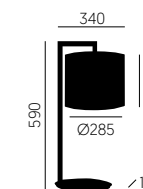

**CM - 0466**

1x E27 - MAX. 60W  
 IP20 CE 230V/150Hz



**oxidado cobre mate**  
 antique copper matte  
 cuivre antique mat

mais acabamentos sob consulta . more finishes on request . plus finitions sur demande p. 255

**chintz preto**  
 black chintz  
 chintz noir

consultar . check . consulter p. 251



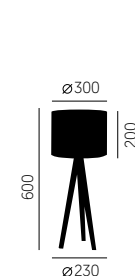

## SHE

**CM - 0463**

1x E27 - MAX. 60W  
 230V | 50Hz

**branco mate**  
 matte white  
 blanc mat

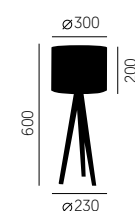
**CM - 0496**

1x E27 - MAX. 60W  
 230V | 50Hz

**madeira faia**  
 beech wood  
 bois de hêtre

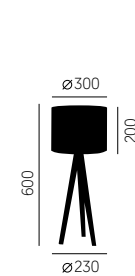
**CM - 0463 IE**

1x E27 - MAX. 60W  
 230V | 50Hz

**inox**  
 stainless steel  
 inox

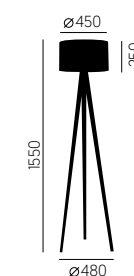
**CP - 1025**

1x E27 - MAX. 60W  
 230V | 50Hz

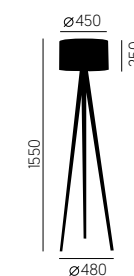
**CP - 1025 IE**

1x E27 - MAX. 60W  
 230V | 50Hz

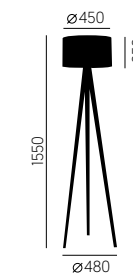
**CP - 1054**

1x E27 - MAX. 60W  
 230V | 50Hz

**madeira faia**  
 beech wood  
 bois de hêtre



**cobre escovado**  
 brushed copper  
 cuivre brossé

**consultar** · check · consulter p. 251

**mais acabamentos sob consulta** · more finishes on request · plus finitions sur demande p. 255

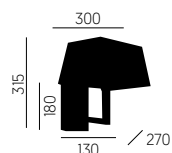

**AP - 1330**

1x E27 - MAX. 40W  
 IP20 CE 230V 1.50Hz

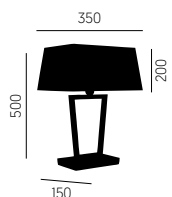

**CM - 0497**

1x E27 - MAX. 60W  
 IP20 CE 230V 1.50Hz



**CM - 0498**

1x E27 - MAX. 60W  
 IP20 CE 230V 1.50Hz

**RISE**

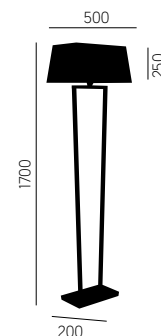

**CP - 1055**

1x E27 - MAX. 60W  
 IP20 CE 230V 1.50Hz



**BIG ROUND**

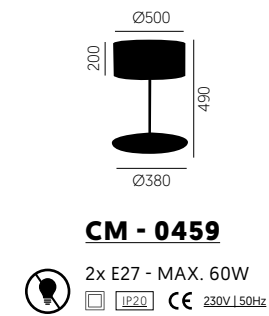
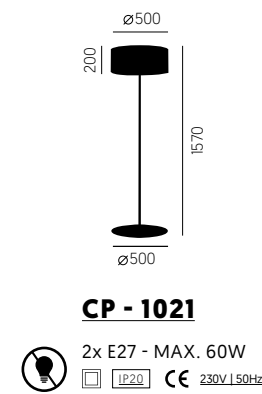
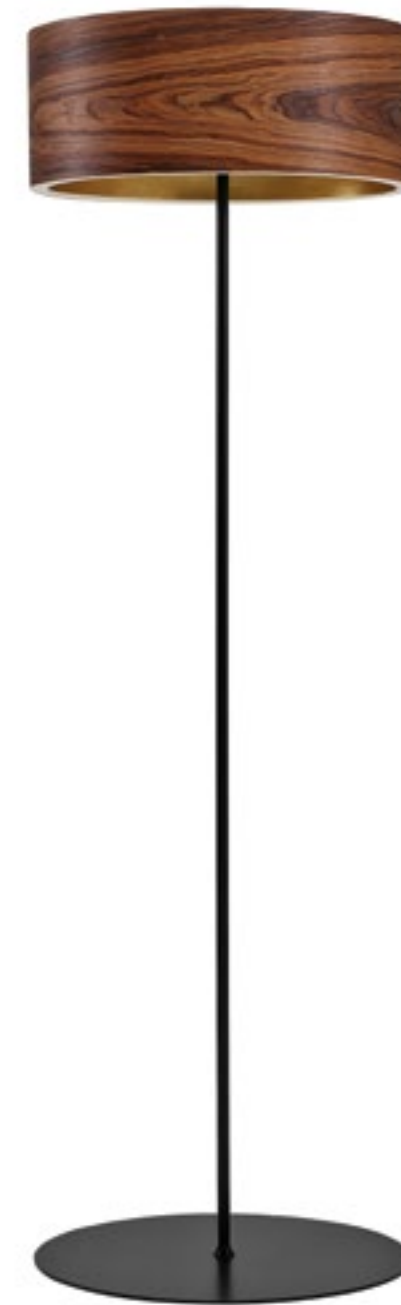

**preto mate**  
matte black  
noir mat

mais acabamentos sob consulta . more finishes on request . plus finitions sur demande p. 255

**madeira escura**  
dark wood  
bois foncé

consultar . check . consulter p. 251









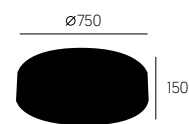

## BIG ROUND

**PF - 0595**

5x E27 - MAX. 60W  
  230V | 50Hz

**PF - 0594**

3x E27 - MAX. 60W  
  230V | 50Hz

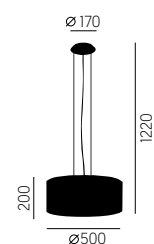
**SU - 0958**

3x E27 - MAX. 60W  
  230V | 50Hz

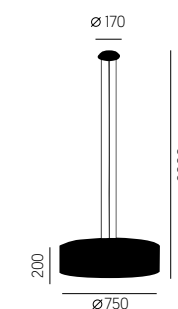
**SU - 0957**

5x E27 - MAX. 60W  
  230V | 50Hz

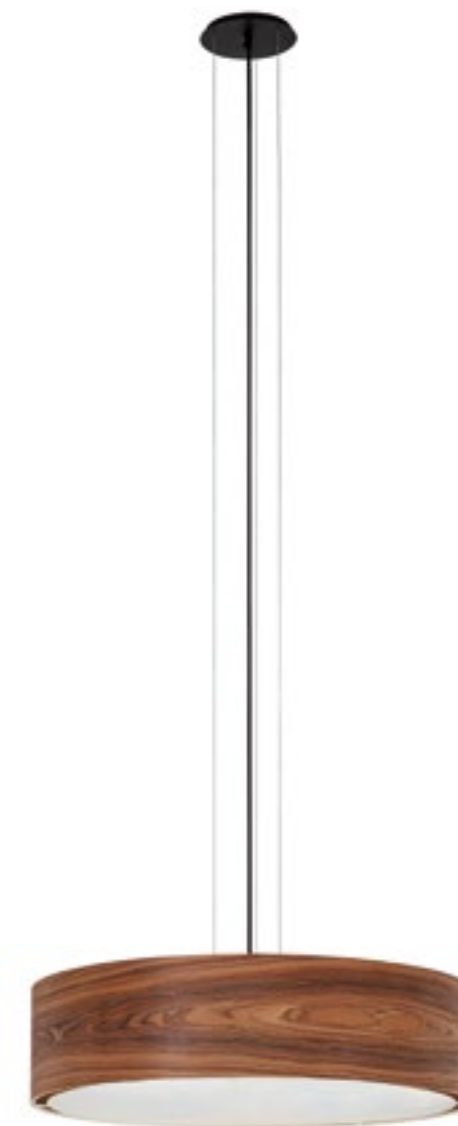

**preto mate**  
 matte black  
 noir mat

mais acabamentos sob consulta . more finishes on request . plus finitions sur demande p. 255



**madeira escura**  
 dark wood  
 bois foncé

consultar . check . consulter p. 251





**BIG SQUARE**



**AP - 1300**

1x E27 - MAX. 60W  
 IP20 CE 230V/150Hz

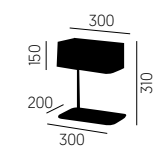

**CM - 0457**

1x E27 - MAX. 60W  
 IP20 CE 230V/150Hz

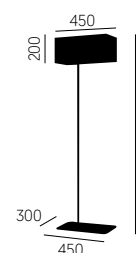

**CP - 1020**

1x E27 - MAX. 60W  
 IP20 CE 230V/150Hz

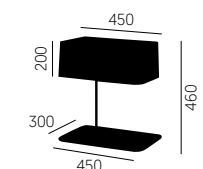

**CM - 0458**

1x E27 - MAX. 60W  
 IP20 CE 230V/150Hz



**branco texturado**  
 textured white  
 blanc poudré

mais acabamentos sob consulta . more finishes on request . plus finitions sur demande p. 255

**cortiça**  
 cork  
 liège

consultar . check . consulter p. 251



BIG SQUARE



ARTINOX PORTUGUESE LIGHTING SINCE 1977

BIG SQUARE

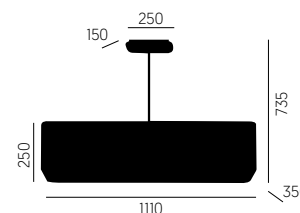

CT - 4227

5x E27 - MAX. 60W  
IP20 CE 230V/150Hz

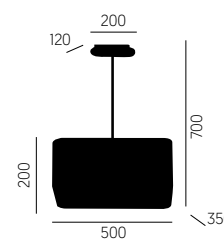

CT - 4226

2x E27 - MAX. 60W  
IP20 CE 230V/150Hz



PF - 0596

2x E27 - MAX. 60W  
IP20 CE 230V/150Hz



PF - 0596

2x E27 - MAX. 60W  
IP20 CE 230V/150Hz

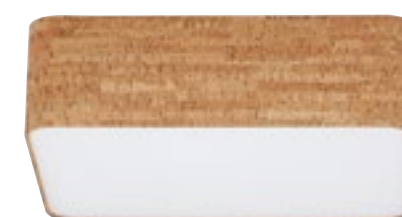

branco texturado  
textured white  
blanc poudré

mais acabamentos sob consulta . more finishes on request . plus finitions sur demande p. 255

cortiça  
cork  
liège

consultar . check . consulter p. 251



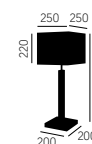

## WOODY MIX

**CM - 0499**

1x E27 - MAX. 60W  
 IP20 CE 230V/50Hz

**CM - 0500**

1x E27 - MAX. 60W  
 1x LED - MAX. 3W  
 3000°K 190lm  
 Driver included  
 IP20 CE 230V/50Hz

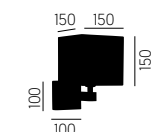
**AP - 1396**

1x E27 - MAX. 40W  
 IP20 CE 230V/50Hz

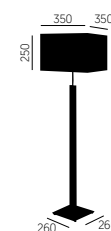
**CP - 1056**

1x E27 - MAX. 60W  
 IP20 CE 230V/50Hz

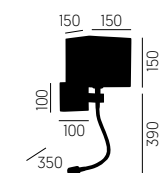
**AP - 1352**

1x E27 - MAX. 40W  
 1x LED - MAX. 3W  
 Driver included  
 IP20 CE 230V/50Hz



**cromado / madeira escura**  
 chrome / dark wood  
 chrome / bois foncé

mais acabamentos sob consulta · more finishes on request · plus finitions sur demande p. 251

**chintz branco**  
 white chintz  
 chintz blanc

consultar · check · consulter p. 251

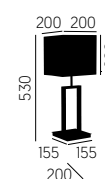

## ARCH

**CM - 3227**

1x E27 - MAX. 60W  
 IP20 CE 230V/1.50Hz

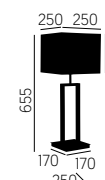
**CM - 3226**

1x E27 - MAX. 60W  
 IP20 CE 230V/1.50Hz

**CP - 1011**

1x E27 - MAX. 60W  
 1x LED - MAX. 3W  
 3000°K 190lm  
 Driver included

IP20 CE 230V/1.50Hz

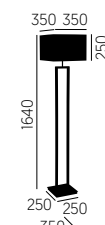
**CP - 1010**

1x E27 - MAX. 60W  
 IP20 CE 230V/1.50Hz

**níquel escovado**  
 brushed nickel  
 nickel brossé

mais acabamentos sob consulta . more finishes on request . plus finitions sur demande p. 251

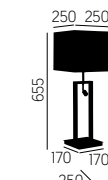
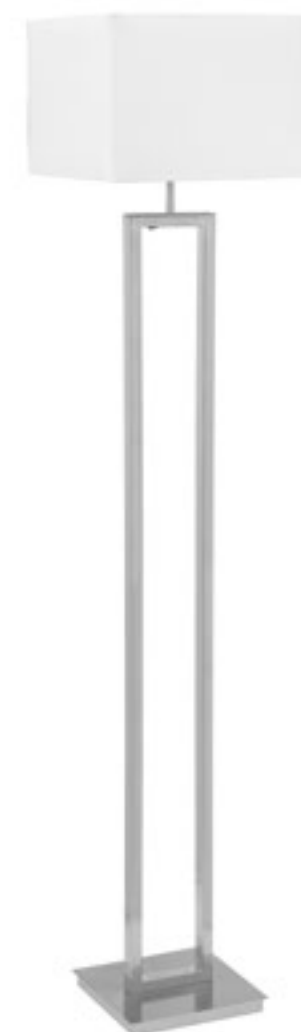
**CM - 0456**

1x E27 - MAX. 60W  
 1x LED - MAX. 3W  
 3000°K 190lm  
 Driver included  
 IP20 CE 230V/1.50Hz

**AP - 1294**

1x E27 - MAX. 40W  
 IP20 CE 230V/1.50Hz

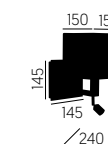
**AP - 2231**

1x E27 - MAX. 40W  
 1x LED - MAX. 3W  
 3000°K 190lm  
 Driver included  
 IP20 CE 230V/1.50Hz

**chintz branco**  
 white chintz  
 chintz blanc

consultar . check . consulter p. 251



## QUADRA

**AP - 2226**

1x E27 - MAX. 40W  
 1x LED - MAX. 3W  
 3000°K 190lm  
 Driver included  
 IP20 CE 230V,150Hz

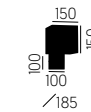
**AP - 2211**

1x E27 - MAX. 40W  
 IP20 CE 230V,150Hz

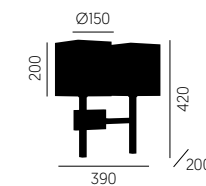
**AP - 2128**

2x E27 - MAX. 40W  
 IP20 CE 230V,150Hz

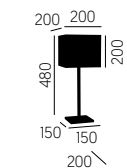
**CM - 3211**

1x E27 - MAX. 60W  
 IP20 CE 230V,150Hz

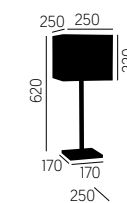
**CM - 3212**

1x E27 - MAX. 60W  
 IP20 CE 230V,150Hz

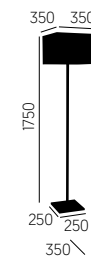
**CP - 0982**

1x E27 - MAX. 60W  
 IP20 CE 230V,150Hz



**cromado**  
 chrome  
 chrome poli

mais acabamentos sob consulta . more finishes on request . plus finitions sur demande p. 251

**chintz branco**  
 white chintz  
 chintz blanc

consultar . check . consulter p. 251

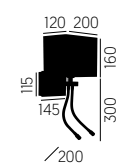

## RECTA

**AP - 1266**

1x E27 - MAX. 40W  
2x LED - MAX. 1W  
Driver included  
5000°K 150lm  
IP20 CE 230V/150Hz

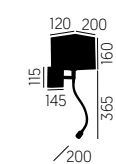
**AP - 1267**

1x E27 - MAX. 40W  
1x LED - MAX. 1W  
5000°K 150lm  
Driver included  
IP20 CE 230V/150Hz

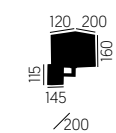
**AP - 2213**

1x E27 - MAX. 40W  
IP20 CE 230V/150Hz

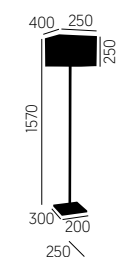
**CP - 0984**

1x E27 - MAX. 60W  
IP20 CE 230V/150Hz

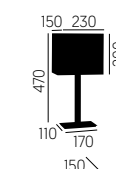
**CM - 3213**

1x E27 - MAX. 60W  
IP20 CE 230V/150Hz

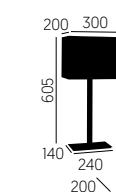
**CM - 0387**

1x E27 - MAX. 60W  
IP20 CE 230V/150Hz

níquel escovado  
brushed nickel  
nickel brossé

mais acabamentos sob consulta . more finishes on request . plus finitions sur demande p. 251

chintz bege  
beige chintz  
chintz beige

consultar . check . consulter p. 251



## ROUND

**AP - 1166**

1x E27 - MAX. 40W  
 230V/1.50Hz

**AP - 1168**

1x E27 - MAX. 40W  
 1x LED - MAX. 1W  
 5000°K 150lm  
 Driver included  
 230V/1.50Hz

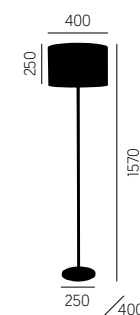
**CP - 0983**

1x E27 - MAX. 60W  
 230V/1.50Hz

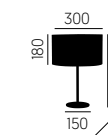
**CM - 0385**

1x E27 - MAX. 60W  
 230V/1.50Hz

**CM - 0386**

1x E27 - MAX. 60W  
 230V/1.50Hz



mais acabamentos sob consulta . more finishes on request . plus finitions sur demande p. 255



consultar . check . consulter p. 251





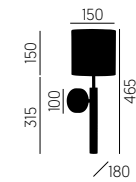

## CRIS

**AP - 2228**

1x E27 - MAX. 40W  
 IP20 CE 230V/50Hz

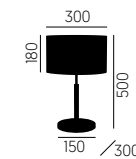
**CM - 0431**

1x E27 - MAX. 60W  
 IP20 CE 230V/50Hz

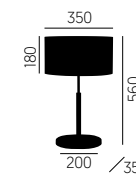
**CM - 0426**

1x E27 - MAX. 60W  
 IP20 CE 230V/50Hz

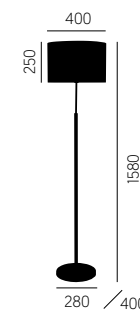
**CP - 1002**

1x E27 - MAX. 60W  
 IP20 CE 230V/50Hz



**cromado**  
 chrome  
 chrome poli

mais acabamentos sob consulta . more finishes on request . plus finitions sur demande p. 251

**chintz preto**  
 black chintz  
 chintz noir

consultar . check . consulter p. 251

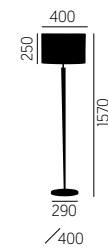

**CP - 1014**

1x E27 - MAX. 60W  
 IP20 CE 230V | 50Hz

**banho ouro**  
 gold plate  
 or

mais acabamentos sob consulta . more finishes on request . plus finitions sur demande p. 255

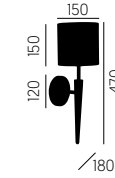

**AP - 1282**

1x E27 - MAX. 40W  
 IP20 CE 230V | 50Hz

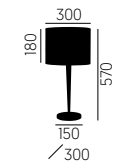

**CM - 0430**

1x E27 - MAX. 60W  
 IP20 CE 230V | 50Hz

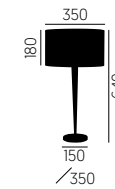

**CM - 0451**

1x E27 - MAX. 60W  
 IP20 CE 230V | 50Hz

**chintz preto**  
 black chintz  
 chintz noir

consultar . check . consulter p. 251

**CONE**



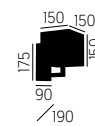

## BRIDGE

**AP - 1268**

1x E27 - MAX. 40W  
 IP20 CE 230V, 150Hz

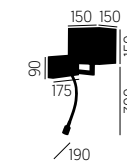
**AP - 1269**

1x E27 - MAX. 40W  
 1x LED - MAX. 3W  
 3000°K 190lm  
 Driver included  
 IP20 CE 230V, 150Hz  
**Right Side Version (AP-1270)**

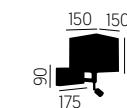
**AP - 1353**

1x E27 - MAX. 40W  
 1x LED - MAX. 3W  
 3000°K 190lm  
 Driver included  
 IP20 CE 230V, 150Hz  
**Right Side Version (AP-1354)**

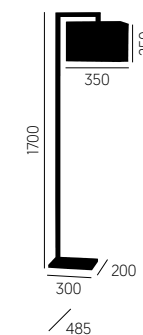
**CP - 1012**

1x E27 - MAX. 60W  
 IP20 CE 230V, 150Hz

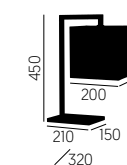
**CM - 0448**

1x E27 - MAX. 60W  
 IP20 CE 230V, 150Hz



**níquel escovado**  
 brushed nickel  
 nickel brossé

mais acabamentos sob consulta . more finishes on request . plus finitions sur demande p. 251

**chintz branco**  
 white chintz  
 chintz blanc

consultar . check . consulter p. 251

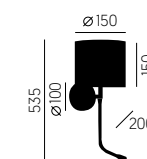

## LOFT

**AP - 1311**

1x E27 - MAX. 40W  
 1x LED - MAX. 1W  
 5000°K 150lm  
 Driver included  
 IP20 CE 230V/50Hz

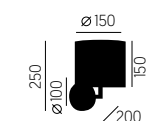
**AP - 1312**

1x E27 - MAX. 40W  
 IP20 CE 230V/50Hz

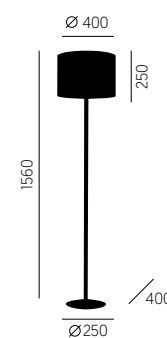
**CP - 1030**

1x E27 - MAX. 60W  
 IP20 CE 230V/50Hz

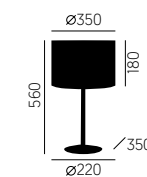
**CM - 0469**

1x E27 - MAX. 60W  
 IP20 CE 230V/50Hz



 **oxidado escuro**  
 antique dark  
 antique foncé

mais acabamentos sob consulta . more finishes on request . plus finitions sur demande p. 251

 **chintz branco**  
 white chintz  
 chintz blanc

consultar . check . consulter p. 251

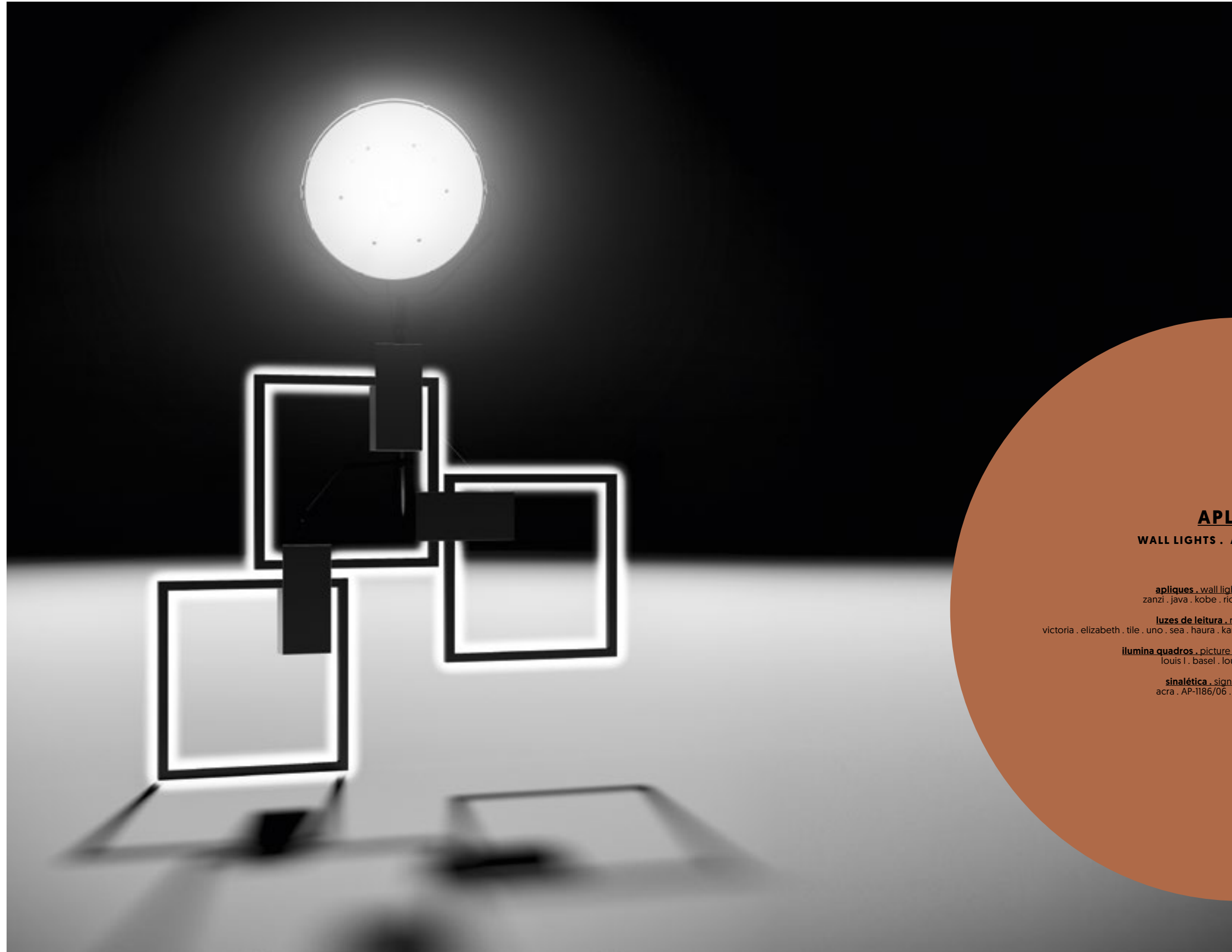

**APLIQUES**  
WALL LIGHTS . APPLIQUES MURALES

**apliques** . wall lights . appliques murales  
zanzi . java . kobe . rio . nico . paul . kube . nova

**luzes de leitura** . reading lights . liseuses  
victoria . elizabeth . tile . uno . sea . haura . kandy . kandy recess . snake . laska . agra . flex . bed

**ilumina quadros** . picture lights . appliques pour tableau  
louis I . basel . louis II . louis III . louis IV

**senalética** . signaletics . signalisation  
acra . AP-1186/06 . AP-1185/20 . AP-1184/21

**APLIQUES**

WALL LIGHTS . APPLIQUES MURALES

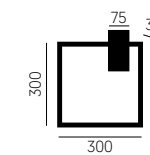
**ZANZI  
AP - 1355**

1x LED - MAX. 6W  
3000°K 400lm/mt  
Driver included

⊕ IP20 CE 230V 1.50Hz

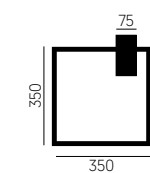
**ZANZI  
AP - 1356**

1x LED - MAX. 7W  
3000°K 400lm/mt  
Driver included

⊕ IP20 CE 230V 1.50Hz

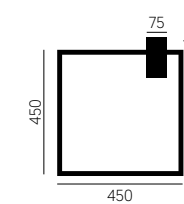
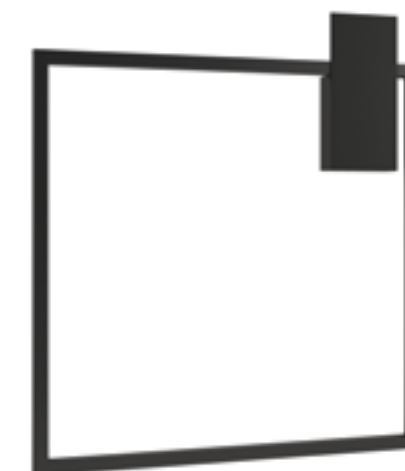
**ZANZI  
AP - 1357**

1x LED - MAX. 9W  
3000°K 400lm/mt  
Driver included

⊕ IP20 CE 230V 1.50Hz

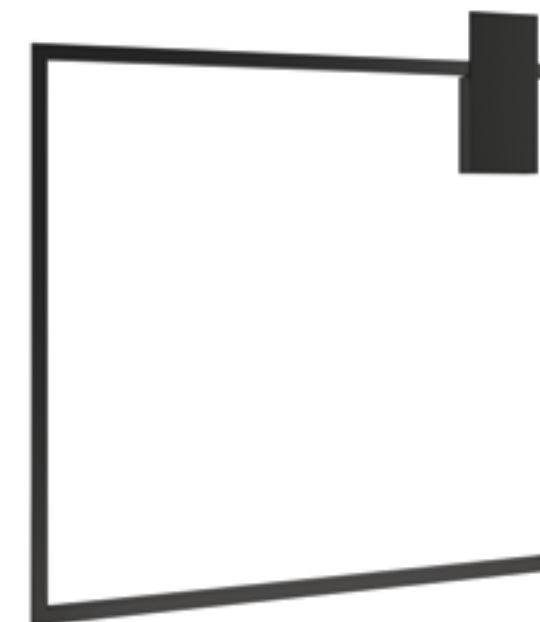

mais acabamentos sob consulta . more finishes on request . plus finitions sur demande p. 255

APLIQUES  
WALL LIGHTS . APPLIQUES MURALES



ARTINOX PORTUGUESE LIGHTING SINCE 1977



**APLIQUES**  
WALL LIGHTS . APPLIQUES MURALES

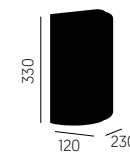

**JAVA**  
**AP - 1358**

1x E14 - MAX. 40W  
IP20 CE 230V, 1.50Hz

 **oxidado**  
antique gold  
or antique

mais acabamentos sob consulta . more finishes on request . plus finitions sur demande p. 255





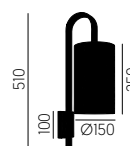

## APLIQUES

WALL LIGHTS . APPLIQUES MURALES





**KOBE**  
**AP - 1359**

1x E27 - MAX. 40W  
  230V 1.50Hz

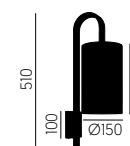
**oxidado escuro escovado mate**  
 dark antique brushed matte  
 antique foncé brossé mat





**KOBE**  
**AP - 1359**

1x E27 - MAX. 40W  
  230V 1.50Hz

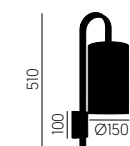
**preto mate**  
 matte black  
 noir mat



**KOBE**  
**AP - 1359**

1x E27 - MAX. 40W  
  230V 1.50Hz

**oxidado**  
 antique gold  
 or antique



vários  
 various  
 diverse

mais acabamentos sob consulta . more finishes on request . plus finitions sur demande p. 251



richmond  
 richmond  
 richmond

consultar . check . consulter p. 251









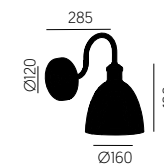

APLIQUES

WALL LIGHTS . APPLIQUES MURALES



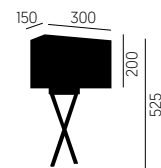

**RIO**  
**AP - 1360**

1x E27 - MAX. 40W  
   230V / 50Hz



**RIO**  
**AP - 1323**

1x E27 - MAX. 40W  
   230V / 50Hz

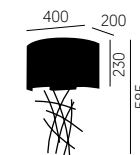

**RIO**  
**AP - 1327**

1x E27 - MAX. 60W  
   230V / 50Hz



 **oxidado / preto mate**  
 antique gold / matte black  
 or antique / noir mat

mais acabamentos sob consulta . more finishes on request . plus finitions sur demande p. 255

 **chintz preto**  
 black chintz  
 chintz noir

consultar . check . consulter p. 251





## APLIQUES

WALL LIGHTS . APPLIQUES MURALES

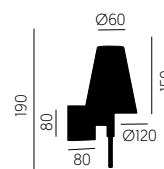
**NICO**  
**AP - 1361**

1x E14 - MAX. 40W  
 230V 1.50Hz

**oxidado mate**  
 antique gold matte  
 or antique mat

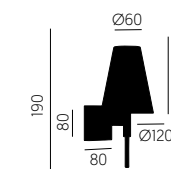
**NICO**  
**AP - 1361**

1x E14 - MAX. 40W  
 230V 1.50Hz

**cromado**  
 chrome  
 chrome poli

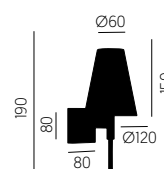
**NICO**  
**AP - 1361**

1x E14 - MAX. 40W  
 230V 1.50Hz

**cobre brilhante**  
 glossy copper  
 cuivre brillant

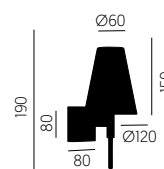
**NICO**  
**AP - 1361**

1x E14 - MAX. 40W  
 230V 1.50Hz

**banho ouro**  
 gold plate  
 or

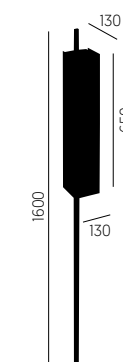
**PAUL**  
**AP - 1324**

1x LED - MAX. 8W  
 3200°K 540lm/mt  
 Driver incluído  
 230V 1.50Hz

**cromado**  
 chrome  
 chrome poli



**vários**  
 various  
 diverse

**mais acabamentos sob consulta** . more finishes on request . plus finitions sur demande p. 255



**KUBE**  
**AP - 1176**

1x GU10 - MAX. 50W  
  230V/150Hz

**níquel escovado**  
 brushed nickel  
 nickel brossé



**KUBE**  
**AP - 1197**

1x G9 - MAX. 25W  
  230V/150Hz

**preto mate**  
 matte black  
 noir mat



**vários**  
 tradução em  
 tradução fr

[mais acabamentos sob consulta](#) . more finishes on request . plus finitions sur demande p. 255

## APLIQUES

WALL LIGHTS . APPLIQUES MURALES

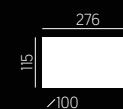

**NOVA**  
**AP - 1196/15**

1x E27 - MAX. 60W  
  230V/150Hz

**níquel escovado**  
 brushed nickel  
 nickel brossé

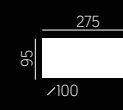

**NOVA**  
**AP - 1196**

1x E27 - MAX. 60W  
  230V/150Hz

**preto mate**  
 matte black  
 noir mat



**vários**  
 various  
 diverse

[mais acabamentos sob consulta](#) . more finishes on request . plus finitions sur demande p. 255

**LUZES DE LEITURA**  
READING LIGHTS . LISEUSES



**LUZES DE LEITURA**  
READING LIGHTS . LISEUSES



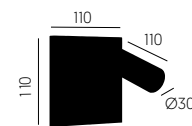

**VICTORIA**  
**AP - 1362**

1x LED - MAX. 3W  
3000°K 190lm  
Driver included

⊕ IP20 CE 230V 1.50Hz

**oxidado escuro escovado mate**  
dark antique brushed matte  
antique foncé brossé mat

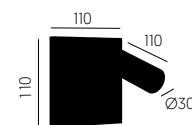
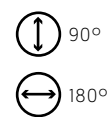

**VICTORIA**  
**AP - 1362**

1x LED - MAX. 3W  
3000°K 190lm  
Driver included

⊕ IP20 CE 230V 1.50Hz

**branco mate**  
matte white  
blanc mat

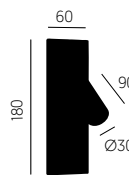
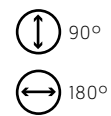

**ELIZABETH**  
**AP - 1363**

1x LED - MAX. 3W  
3000°K 190lm  
Driver included

⊕ IP20 CE 230V 1.50Hz

**oxidado escuro escovado mate**  
dark antique brushed matte  
antique foncé brossé mat

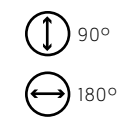

**ELIZABETH**  
**AP - 1363**

1x LED - MAX. 3W  
3000°K 190lm  
Driver included

⊕ IP20 CE 230V 1.50Hz

**branco mate**  
matte white  
blanc mat

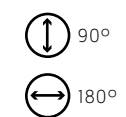

**LUZES DE LEITURA**

READING LIGHTS . LISEUSES



vários  
various  
diverse

mais acabamentos sob consulta . more finishes on request . plus finitions sur demande p. 255



100%

PORTUGUESE  
LIGHTING



**LUZES DE LEITURA**  
READING LIGHTS . LISEUSES

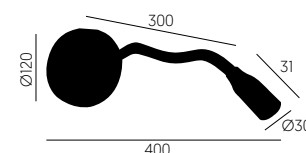

**TILE**  
**AP - 1317**

1x LED - MAX. 3W  
3000°K 190lm  
Driver included  
IP20 CE 230V 1.50Hz

**cromado / preto mate**  
chrome / matte black  
chrome poli / noir mat

**cromado / vermelho**  
chrome / red  
chrome poli / rouge

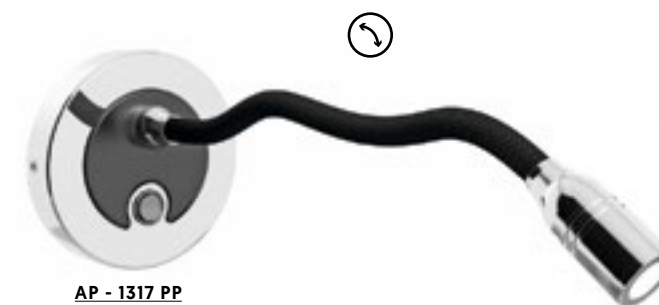

AP - 1317 PP

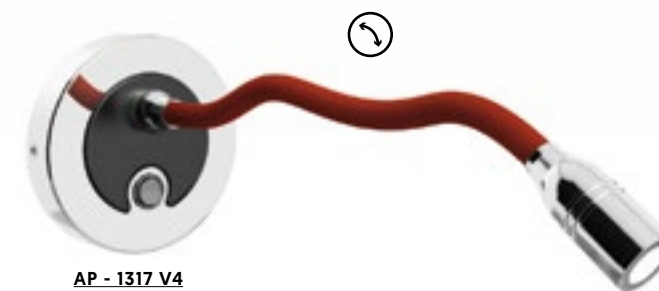

AP - 1317 V4

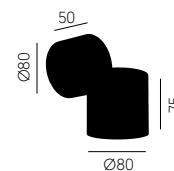

**UNO**  
**AP - 1364**

1x GU10 - MAX. 50W  
IP20 CE 230V 1.50Hz

**preto mate**  
matte black  
noir mat

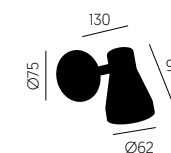

**SEA**  
**AP - 1365**

1x GU10 - MAX. 50W  
IP20 CE 230V 1.50Hz

**preto mate**  
matte black  
noir mat



**vários**  
various  
diverse

mais acabamentos sob consulta . more finishes on request . plus finitions sur demande p. 255





**HAURA**  
**AP - 1366**

1x LED - MAX. 3W + 1x LED - MAX. 8W  
3000°K 190lm + 3200°K 1080lm/mt  
Driver included

IP20 CE 230V / 50Hz

**preto mate**  
matte black  
noir mat

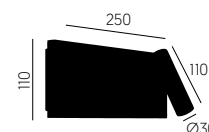

**HAURA**  
**AP - 1366**

1x LED - MAX. 3W + 1x LED - MAX. 8W  
3000°K 190lm + 3200°K 1080lm/mt  
Driver included

IP20 CE 230V / 50Hz

**branco mate**  
matte white  
blanc mat



vários  
various  
diverse

mais acabamentos sob consulta . more finishes on request . plus finitions sur demande p. 255

mais acabamentos sob consulta . more finishes on request . plus finitions sur demande p. 255

**LUZES DE LEITURA**

READING LIGHTS . LISEUSES





## LUZES DE LEITURA

READING LIGHTS . LISEUSES

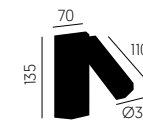
**KANDY**  
**AP - 1367**

1x LED - MAX. 3W  
3000°K 190lm  
Driver included  
  230V 1.50Hz

**oxidado escuro**  
dark antique  
antique foncé

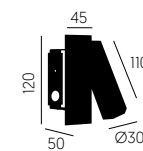
**KANDY RECESS**  
**AP - 1368**

1x LED - MAX. 3W  
3000°K 190lm  
Driver included  
  230V 1.50Hz

**branco mate**  
matte white  
blanc mat



 **vários**  
various  
diverse

**mais acabamentos sob consulta** . more finishes on request . plus finitions sur demande p. 255



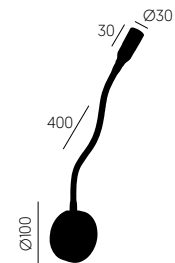

**SNAKE**  
**AP - 1369**

1x LED - MAX. 3W  
3000°K 190lm  
Driver included  
IP20 CE 230V/150Hz

**cromado**  
chrome  
chrome poli

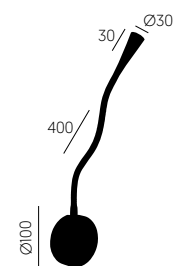
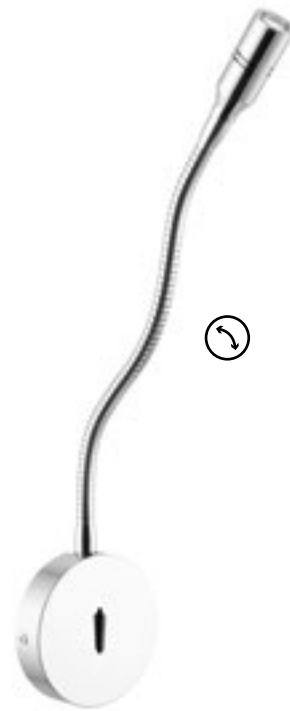

**SNAKE**  
**AP - 1370**

1x LED - MAX. 3W  
3000°K 190lm  
Driver included  
IP20 CE 230V/150Hz

**preto mate**  
matte black  
noir mat

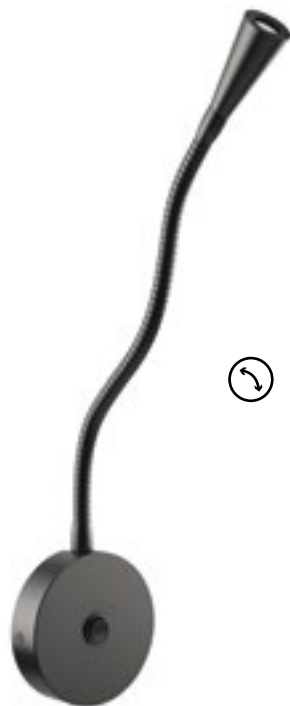

**LUZES DE LEITURA**

READING LIGHTS . LISEUSES



**LASKA**  
**AP - 1371**

1x LED - MAX. 3W  
3000°K 190lm  
Driver included  
IP20 CE 230V/150Hz

**níquel escovado**  
brushed nickel  
nickel brossé

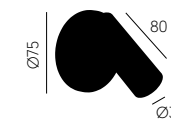

**AGRA**  
**AP - 1372**

1x LED - MAX. 3W  
3000°K 190lm  
Driver included  
IP20 CE 230V/150Hz

**níquel preto**  
black nickel  
nickel noir

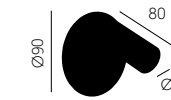

**AGRA**  
**AP - 1373**

1x LED - MAX. 3W  
3000°K 190lm  
Driver included  
IP20 CE 230V/150Hz

**níquel escovado**  
brushed nickel  
nickel brossé





## LUZES DE LEITURA

READING LIGHTS . LISEUSES

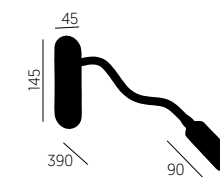
**FLEX**  
**AP - 1344**

1x G9 LED - MAX. 25W  
No driver required  
⊕ IP20 CE 230V/50Hz

**cromado / branco pintado**  
chrome / painted white  
chrome poli / blanc peint

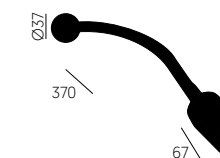
**FLEX**  
**AP - 1343**

1x LED - MAX. 3W  
3000°K 190lm  
Driver included  
⊕ IP20 CE 230V/50Hz

**níquel escovado**  
brushed nickel  
nickel brossé

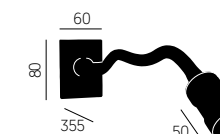
**FLEX**  
**AP - 1345**

1x LED - MAX. 3W  
3000°K 190lm  
Driver included  
⊕ IP20 CE 230V/50Hz

**níquel preto**  
black nickel  
nickel noir



mais acabamentos sob consulta . more finishes on request . plus finitions sur demande p. 255

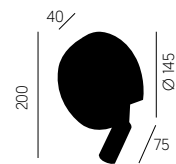

**BED****AP - 1307/16**

1x LED - MAX. 3W  
3000°K 190lm  
Driver included

⊕ IP20 CE 230V 1.50Hz

**Right Side Version (AP-1307/17)**

**cromado**  
chrome  
chrome poli

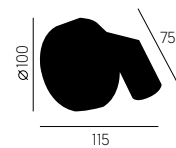
**BED****AP - 1308**

1x LED - MAX. 3W  
3000°K 190lm  
Driver included

⊕ IP20 CE 230V 1.50Hz

**cromado**  
chrome  
chrome poli

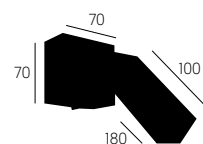
**BED****AP - 1314**

1x LED - MAX. 3W  
3000°K 190lm  
Driver included

⊕ IP20 CE 230V 1.50Hz

**cromado**  
chrome  
chrome poli

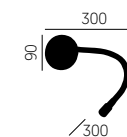
**LUZES DE LEITURA****READING LIGHTS . LISEUSES****FLEX****AP - 1265**

1x LED - MAX. 1W  
5000°K 150lm  
Driver included

⊕ IP20 CE 230V 1.50Hz

**níquel escovado**  
brushed nickel  
nickel brossé

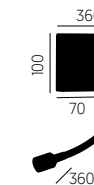
**FLEX****AP - 1275**

1x LED - MAX. 3W  
3000°K 190lm  
Driver included

⊕ IP20 CE 230V 1.50Hz

**cromado**  
chrome  
chrome poli

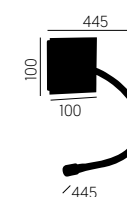
**FLEX****AP - 1276**

1x LED - MAX. 1W  
5000°K 150lm  
Driver included

⊕ IP20 CE 230V 1.50Hz

**preto mate**  
matte black  
noir mat

**FLEX****AP - 1234**

1x LED - MAX. 1W  
5000°K 150lm  
Driver included

⊕ IP20 CE 230V 1.50Hz

**níquel escovado**  
brushed nickel  
nickel brossé



**ILUMINA QUADROS**

PICTURE LIGHTS . APPLIQUES POUR TABLEAU



**ILUMINA QUADROS**

PICTURE LIGHTS . APPLIQUES POUR TABLEAU



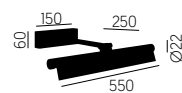

### LOUIS I AP - 1374

LED - MAX. 3,6W  
3200°K 1080lm/mt  
Driver included  
IP20 CE 230V 1.50Hz

**preto mate / oxidado**  
matte black / antique gold  
noir mat / or antique

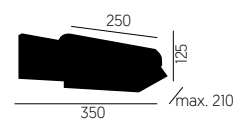
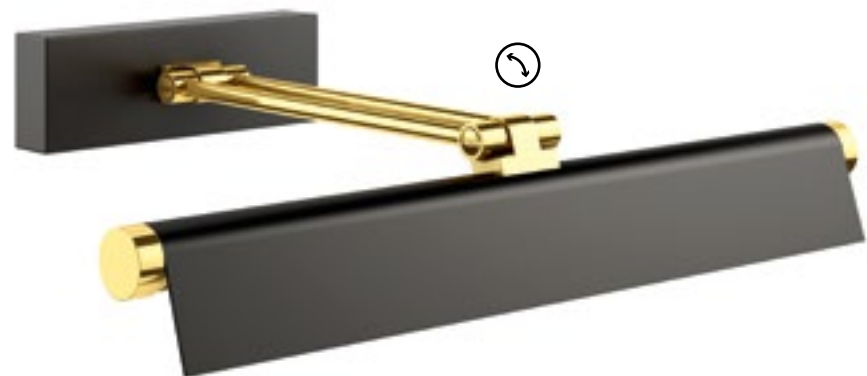

### BASEL AP - 1320

LED - MAX. 3,6W  
3200°K 1080lm/mt  
Driver included  
IP20 CE 230V 1.50Hz

**preto mate / oxidado**  
matte black / antique gold  
noir mat / or antique

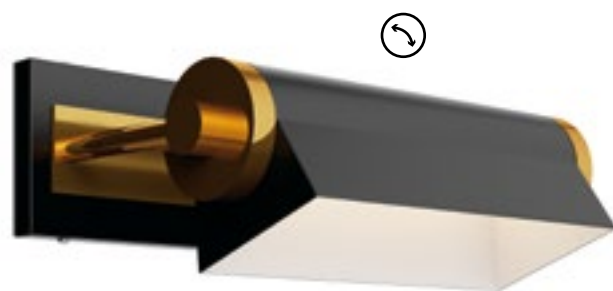

## ILUMINA QUADROS

PICTURE LIGHTS . APPLIQUES POUR TABLEAU

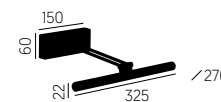

### LOUIS II AP - 1292

LEDs - MAX. 7W  
3200°K 1080lm/mt  
↔ 325mm  
Driver included  
IP20 CE 230V 1.50Hz

**cromado**  
chrome  
chrome poli

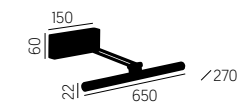

### LOUIS II AP - 1293

LEDs - MAX. 8W  
3200°K 1080lm/mt  
↔ 650mm  
Driver included  
IP20 CE 230V 1.50Hz

**cromado**  
chrome  
chrome poli

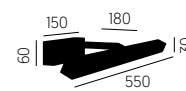
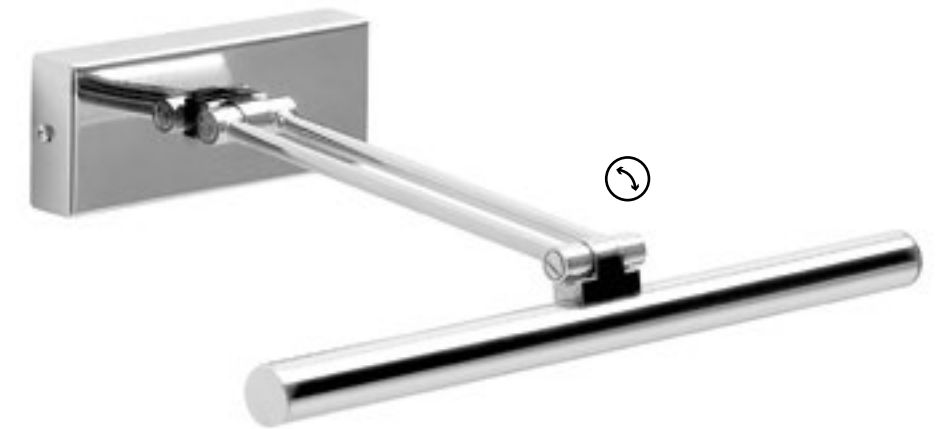

### LOUIS III AP - 1375

LED - MAX. 8W  
3200°K 1080lm/mt  
Driver included  
IP20 CE 230V 1.50Hz

**niquel escovado**  
brushed nickel  
nickel brossé

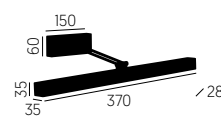
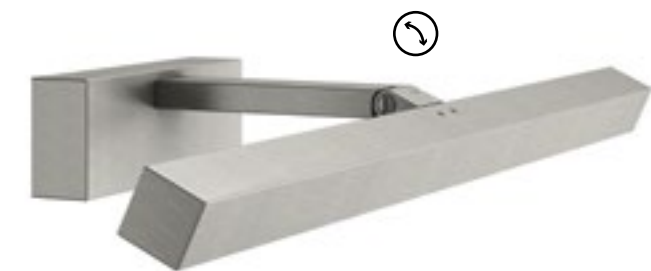

### LOUIS IV AP - 1288

LED - MAX. 5W  
3200°K 1080lm/mt  
↔ 370mm  
Driver included  
IP20 CE 230V 1.50Hz

**niquel escovado**  
brushed nickel  
nickel brossé

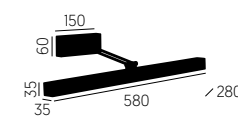

### LOUIS IV AP - 1289

LED - MAX. 8W  
3200°K 1080lm/mt  
↔ 580mm  
Driver included  
IP20 CE 230V 1.50Hz

**niquel escovado**  
brushed nickel  
nickel brossé

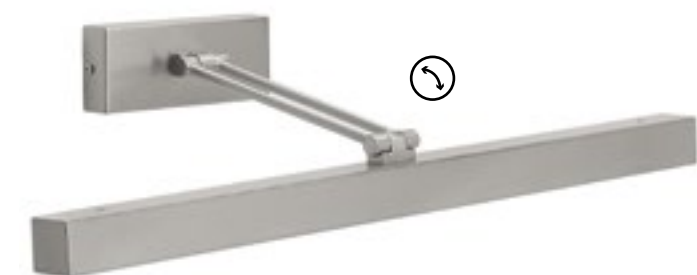

vários  
various  
diverse

mais acabamentos sob consulta . more finishes on request . plus finitions sur demande p. 255



vários  
various  
diverse

mais acabamentos sob consulta . more finishes on request . plus finitions sur demande p. 255



100%

FULL CONTEMPORARY

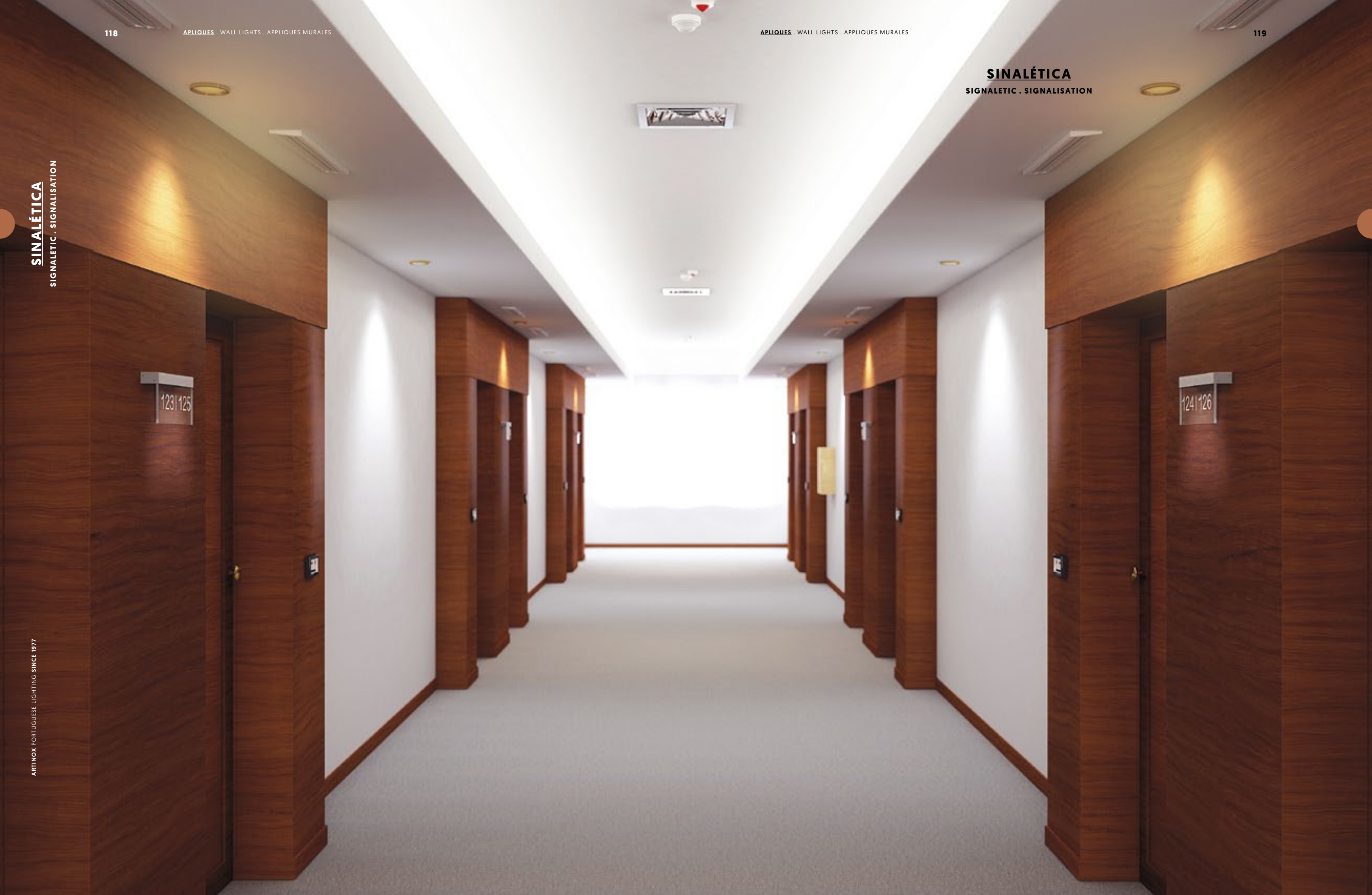

123125

124126



## SINALÉTICA

SIGNALETIC . SIGNALISATION

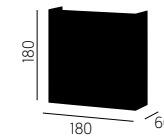

### ACRA AP - 1376

1x LED - MAX. 3W  
3000°K 190lm  
Driver included  
IP20 CE 230V/150Hz

**preto mate**  
matte black  
noir mat



### ACRA AP - 1377

1x LED - MAX. 4,5W  
3000°K 450lm/mt  
Driver included  
IP20 CE 230V/150Hz

**preto mate / oxidado / acrílico**  
matte black / antique gold / acrylic  
noir mat / or antique / acrylique



vários  
various  
diverse

mais acabamentos sob consulta . more finishes on request . plus finitions sur demande p. 255



**Disponível para o AP - 1186/06**  
Available for AP - 1186/06  
Disponible pour AP - 1186/06



**Disponível para o AP - 1185/20**  
Available for AP - 1185/20  
Disponible pour AP - 1185/20

202 | 204  
20

**Disponível para o AP - 1184/21**  
Available for AP - 1184/21  
Disponible pour AP - 1184/21

HOTEL \*\*\*\*\*  
21

## SINALÉTICA

SIGNALETIC . SIGNALISATION



### AP - 1186/06

1x LED - MAX. 1,2W  
5000K 400lm/mt  
Driver included  
IP20 CE 230V 1.50Hz

**níquel escovado**  
brushed nickel  
nickel brossé

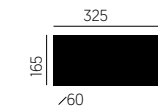

### AP - 1185/20

1x LED - MAX. 1,8W  
5000K 400lm/mt  
Driver included  
IP20 CE 230V 1.50Hz

**níquel escovado**  
brushed nickel  
nickel brossé



### AP - 1184/21

1x LED - MAX. 6W  
5000K 400lm/mt  
Driver included  
IP20 CE 230V 1.50Hz

**níquel escovado**  
brushed nickel  
nickel brossé



**mais acabamentos sob consulta** . more finishes on request . plus finitions sur demande p. 255





## SUSPENSÕES / CANDEIROS DE TETO

SUSPENSIONS / CEILING LAMPS . SUSPENSIONS / LAMPES SUSPENDUES

teto . ceiling . lampes suspendues

dario . chicago . santa . balti . grand balti . snow round . snow grand round . snow square . snow grand square . cork . diva . hook . sierra . miro . bell . song . kings . lucas . masti . olympuz . roots . moon . cluster . begood

plafond . plafond . plafonnier . azores square . azores round



**TETO**  
CEILING . LAMPES SUSPENDUES

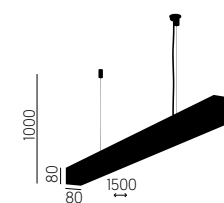

**DARIO**  
**SU - 0963**

1x T5 - MAX. 28W  
↔ 1500mm  
⊕ IP20 CE 230V.150Hz

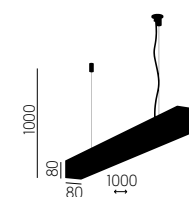

**DARIO**  
**SU - 0964**

1x T5 - MAX. 21W  
↔ 1000mm  
⊕ IP20 CE 230V.150Hz

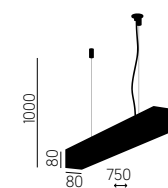

**DARIO**  
**SU - 0965**

1x T5 - MAX. 13W  
↔ 750mm  
⊕ IP20 CE 230V.150Hz



⊗ **Cinza Ral 7016**  
Grey Ral 7016  
Gris Ral 7016

mais acabamentos sob consulta . more finishes on request . plus finitions sur demande p. 255



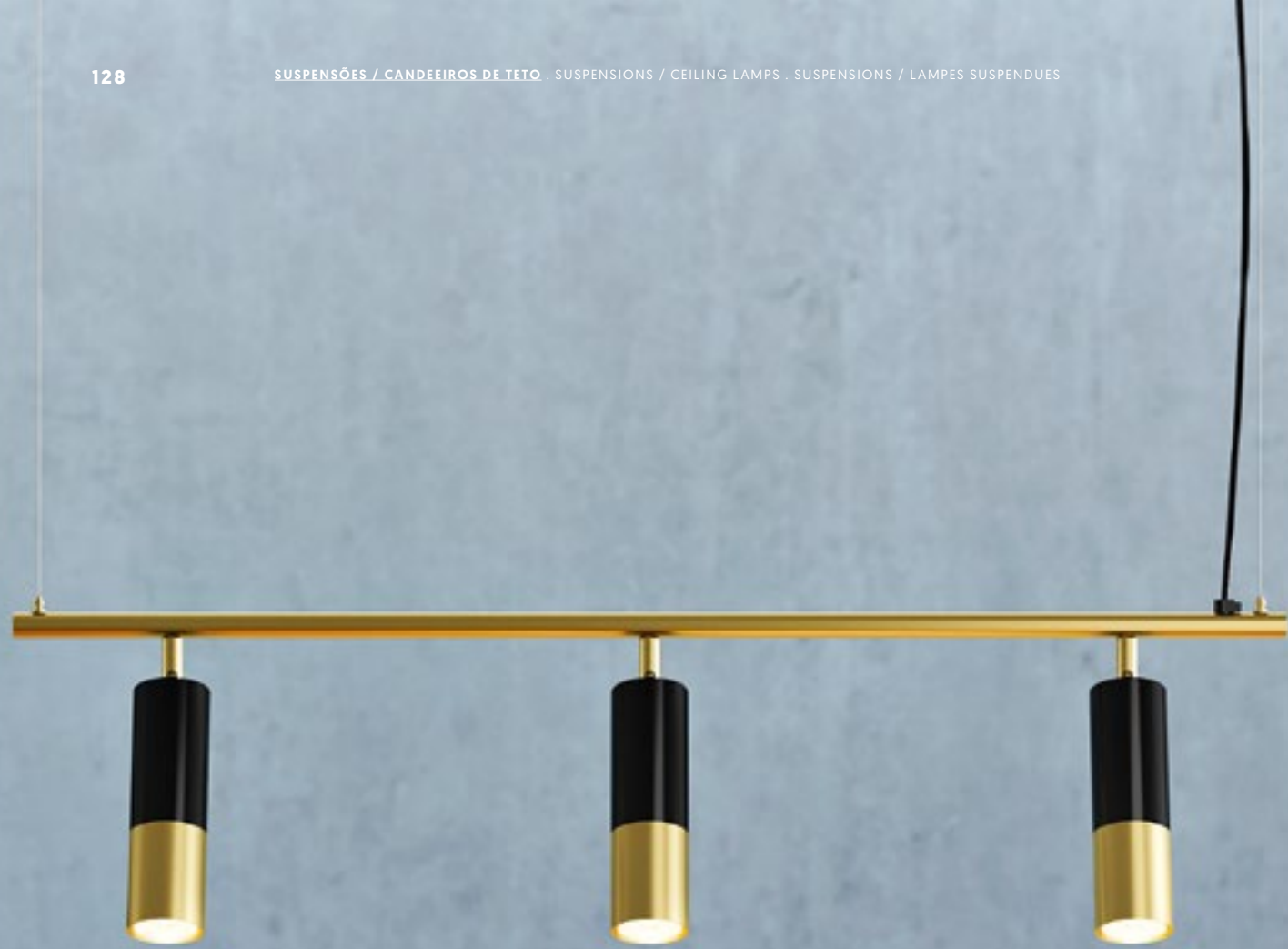

**TETO**  
CEILING . LAMPES SUSPENDUES

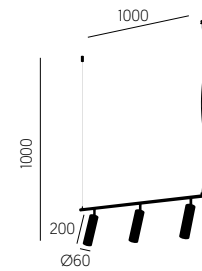

**CHICAGO**  
**SU - 0966**

3x GU10 - MAX. 50W  
 230V 150Hz

**oxidado / preto mate**  
 antique gold / matte black  
 or antique / noir mat

mais acabamentos sob consulta . more finishes on request . plus finitions sur demande p. 255





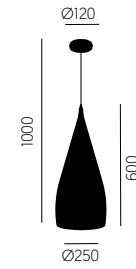

## TETO

CEILING . LAMPES SUSPENDUES



### SANTA SU - 0967

1x E27 - MAX. 60W  
   230V 1.50Hz

**preto mate / cobre pintado**  
 matte black / painted copper  
 noir mat / cuivre peint

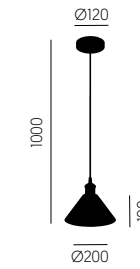



### SANTA SU - 0968

1x E27 - MAX. 60W  
   230V 1.50Hz

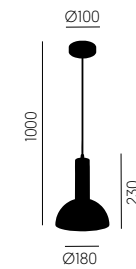
**preto mate / oxidado**  
 matte black / antique gold  
 noir mat / or antique



### SANTA SU - 0961

1x E27 - MAX. 60W  
   230V 1.50Hz

**preto mate / branco**  
 matte black / white  
 noir mat / blanc

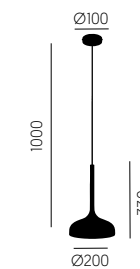

### SANTA SU - 0969

1x G9 - MAX. 25W  
   230V 1.50Hz

**oxidado escuro**  
 dark antique  
 antique foncé



**mais acabamentos sob consulta** . more finishes on request . plus finitions sur demande p. 255

TETO

CEILING . LAMPES SUSPENDUES



## TETO

CEILING . LAMPES SUSPENDUES

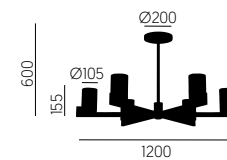

### BALTÍ

#### CT - 4233/6

6x E27 - MÁX. 60W  
 IP20 CE 230V 150Hz

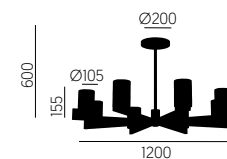

### GRAND BALTÍ

#### CT - 4233/8

8x E27 - MÁX. 60W  
 IP20 CE 230V 150Hz



 **oxidado mate**  
 antique gold matte  
 or antique mat

mais acabamentos sob consulta . more finishes on request . plus finitions sur demande p. 255

 **vidro fosco**  
 frosted glass  
 verre dépoli

consultar . check . consulter p. 251





**TETO**  
CEILING . LAMPES SUSPENDUES

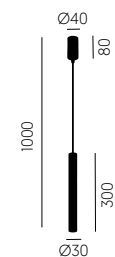

**SNOW ROUND**  
**SU - 0970**

1x LED - MAX. 3W  
3000°K 190lm  
Driver included  
IP20 CE 230V 150Hz

**preto mate / oxidado**  
matte black / antique gold  
noir mat / or antique

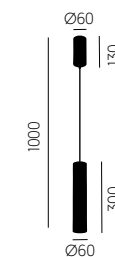

**SNOW GRAND ROUND**  
**SU - 0971**

1x LED - MAX. 8W  
3000°K 688lm  
Driver not included  
IP20 CE 230V 150Hz

**oxidado**  
antique gold  
or antique

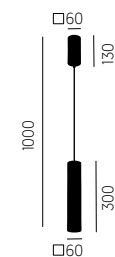

**SNOW SQUARE**  
**SU - 0972**

1x LED - MAX. 8W  
3000°K 688lm  
No driver required  
IP20 CE 230V 150Hz

**preto mate**  
matte black  
noir mat

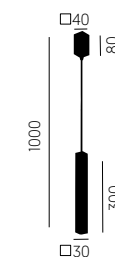

**SNOW GRAND SQUARE**  
**SU - 0973**

1x LED - MAX. 3W  
3000°K 190lm  
Driver included  
IP20 CE 230V 150Hz

**cinza ral 7016**  
grey ral 7016  
gris ral 7016



mais acabamentos sob consulta . more finishes on request . plus finitions sur demande p. 255





TETO

CEILING . LAMPES SUSPENDUES

A FINEST PORTUGUESE LIGHTING SINCE 1977

## TETO

CEILING . LAMPES SUSPENDUES

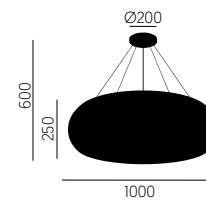

### CORK

#### SU - 0974

5x E27 - MAX. 60W  
 ⚡ E27 CE 230V 1.50Hz

🏠 níquel escovado  
 brushed nickel  
 nickel brossé

mais acabamentos sob consulta . more finishes on request . plus finitions sur demande p. 255

🏠 cortiça  
 cork  
 liège

consultar . check . consulter p. 251

100%  
 FULL CORK  
 COLLECTION



**TETO**  
CEILING . LAMPES SUSPENDUES

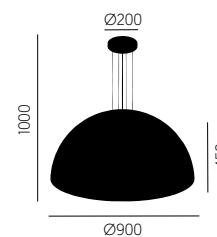

**DIVA**  
**SU - 0975**

5x E27 - MAX. 60W  
IP20 CE 230V 150Hz

preto mate / dourado  
matte black / gold  
noir mat / or

mais acabamentos sob consulta . more finishes on request . plus finitions sur demande p. 255





TETO

CEILING . LAMPES SUSPENDUES



ARTINOX PORTUGUESE LIGHTING SINCE 1977

TETO  
CEILING . LAMPES SUSPENDUES

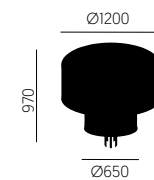

**HOOK**  
**SU - 0976**

15x E27 - MAX. 60W  
IP20 CE 230V 1.50Hz

oxidado  
antique gold  
or antique

mais acabamentos sob consulta . more finishes on request . plus finitions sur demande p. 255

linho  
linen  
lin

consultar . check . consulter p. 251





## TETO

CEILING . LAMPES SUSPENDUES

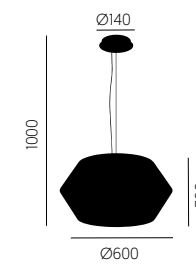

### SIERRA SU - 0977

1x E27 - MAX. 60W  
   230V 1.50Hz

 **níquel escovado**  
 brushed nickel  
 nickel brossé

mais acabamentos sob consulta . more finishes on request . plus finitions sur demande p. 255

 **preto / dourado**  
 black / gold  
 noir / or

consultar . check . consulter p. 251

TETO  
CEILING . LAMPES SUSPENDUES

**HOTEL**  
★★★★★

ARTINOX PORTUGUESE LIGHTING SINCE 1977



**TETO**  
CEILING . LAMPES SUSPENDUES

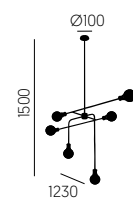

**MIRO**  
**CT - 4234**

6x E27 - MAX. 60W  
IP20 CE 230V 1.50Hz

 oxidado  
antique gold  
or antique

mais acabamentos sob consulta . more finishes on request . plus finitions sur demande p. 255





**TETO**  
CEILING . LAMPES SUSPENDUES

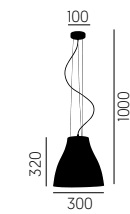

**BELL**  
**SU - 0911**

1x E27 - MAX. 60W  
IP20 CE 320V 150Hz

**aluminio pintado**  
painted aluminium  
aluminium peint





mais acabamentos sob consulta . more finishes on request . plus finitions sur demande p. 255

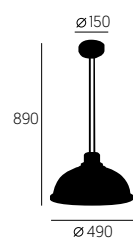





**SONG**  
**SU - 0963**

1x E27 - MAX. 40W  
  230V/150Hz

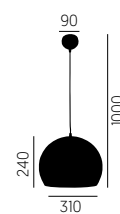
**cromado**  
chrome  
chrome poli





**KINGS**  
**SU - 0910**

1x E27 - MAX. 60W  
  320V/150Hz

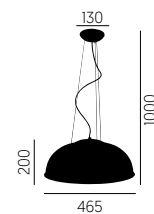
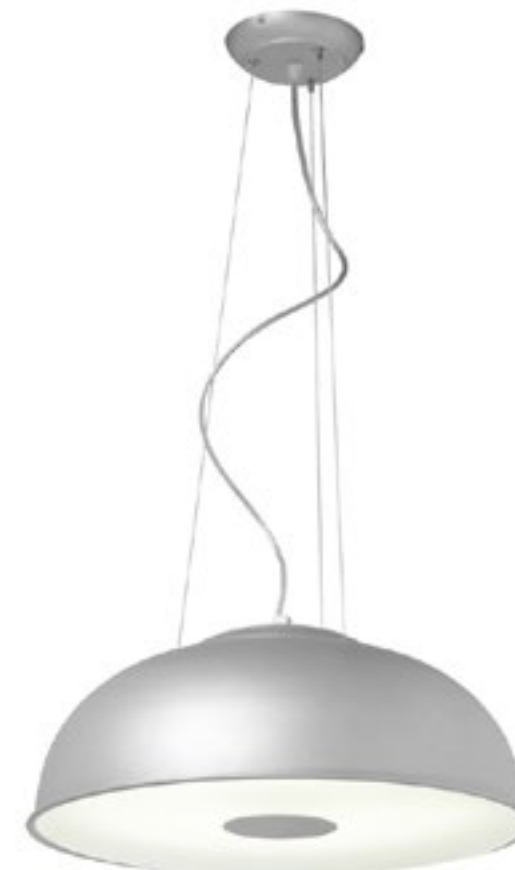
**preto brilhante**  
glossy black  
noir brillant



**SONG**  
**SU - 0912**

1x TR5 - MAX. 22W  
 1x TR5 - MAX. 60W  
  230V/150Hz

**aluminio pintado**  
painted aluminium  
aluminium peint

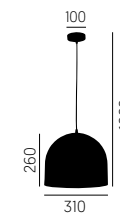

**KINGS**  
**SU - 0955**

1x E27 - MAX. 60W  
  320V/150Hz

**branco brilhante**  
glossy white  
blanc brillant



**vários**  
various  
diverse

mais acabamentos sob consulta . more finishes on request . plus finitions sur demande p. 255



**vários**  
various  
diverse

mais acabamentos sob consulta . more finishes on request . plus finitions sur demande p. 255

**TETO**  
CEILING . LAMPES SUSPENDUES

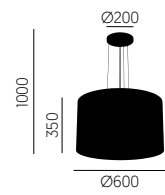

**LUCAS**  
**SU - 0978**

3x E27 - MAX. 60W  
IP20 CE 230V.1.50Hz

**níquel escovado**  
brushed nickel  
nickel brossé

mais acabamentos sob consulta . more finishes on request . plus finitions sur demande p. 255

**richmond 546008 black**  
richmond 546008 black  
richmond 546008 black

consultar . check . consulter p. 251

**TETO**  
CEILING . LAMPES SUSPENDUES

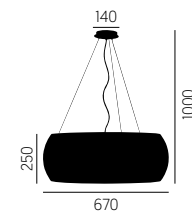

**MASTI**  
**SU - 0922**

3x E27 - MAX. 60W  
IP20 CE 230V.1.50Hz

**oxidado**  
antique gold  
or antique

mais acabamentos sob consulta . more finishes on request . plus finitions sur demande p. 255

**organza dourado**  
organza gold  
organza or

consultar . check . consulter p. 251



**TETO**  
CEILING . LAMPES SUSPENDUES

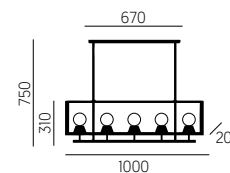

**OLYMPUZ**  
**CT - 4231**

5x E27 - MAX. 60W  
IP20 CE 230V 1.50Hz

**cobre brilhante**  
glossy copper  
cuivre brillant

mais acabamentos sob consulta . more finishes on request . plus finitions sur demande p. 255





**TETO**  
CEILING . LAMPES SUSPENDUES

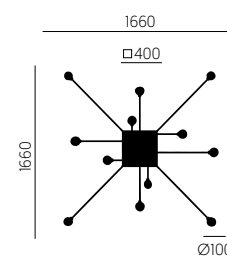

**ROOTS**  
**CT - 4232**

12x G9 - MAX. 25W  
IP20 CE 230V 1.50Hz

 **latão polido**  
polished brass  
laiton poli

mais acabamentos sob consulta . more finishes on request . plus finitions sur demande p. 255







Jean-Paul Marzais

Jean-Paul Marzais possui um design sóbrio e refinado. As suas criações ocupam o espaço para torná-lo um lugar de paz e serenidade.

Antes de se interessar pela criação de objetos, Jean-Paul Marzais foi seduzido pelo design gráfico e pela comunicação visual, explorando a noção de "mínimo" e a busca pela simplicidade que aplica no seu design. É um aficionado pela disciplina da essência e densidade.

Jean-Paul Marzais has a sober and refined design. His creations fill the space to make it a place of peace and serenity.

Before becoming interested in creating objects, Jean-Paul Marzais was seduced by graphic design and visual communication, exploring the notion of "minimum" and the pursuit of simplicity in his design.

He is an enthusiast of the discipline of essence and density.

Jean-Paul Marzais revendique un design sobre et raffiné. Ces créations colonisent l'espace pour en faire un territoire de paix et de sérénité.

Avant de s'intéresser à la créations d'objets, Jean-Paul Marzais a tout d'abord été séduit par le design graphique et la communication visuelle, en explorant la notion du « minimum » et la quête de la simplicité qu'il applique aujourd'hui à l'architecture d'intérieur et au design. Il est séduit par la discipline de l'essentiel et la notion du condensé.



**TETO**  
CEILING . LAMPES SUSPENDUES

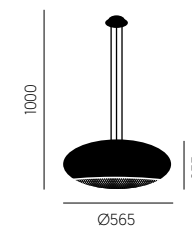
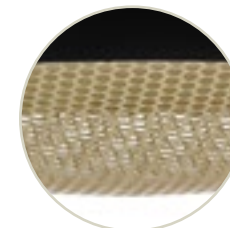
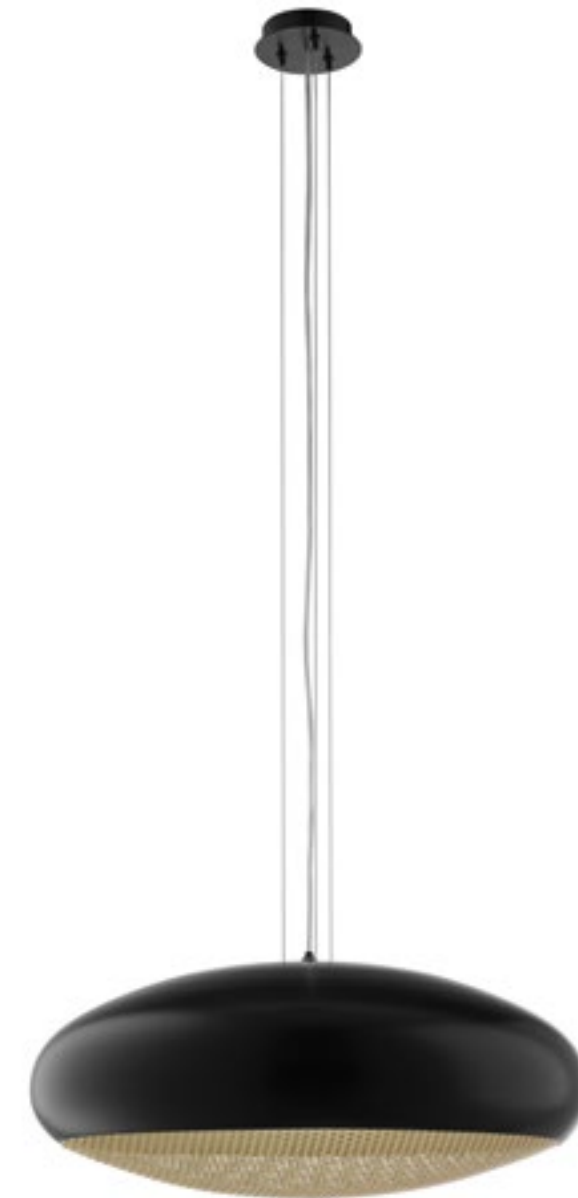

**MOON**  
**SU - 0979**

4x E27 - MAX. 60W  
IP20 CE 230V 1.50Hz







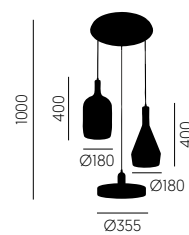

Jean-Paul Marzais

**preto mate / oxidado**  
matte black / antique gold  
noir mat / or antique

mais acabamentos sob consulta . more finishes on request . plus finitions sur demande p. 255



**CLUSTER  
SU - 0980**

3x E27 - MAX. 40W  
     
    230V.1.50Hz

*Jean Paul Narvesi*



 **latão polido / branco**  
 polished brass / white  
 laiton poli / blanc

mais acabamentos sob consulta . more finishes on request . plus finitions sur demande p. 255

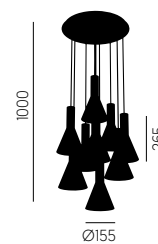
**TETO**  
CEILING . LAMPES SUSPENDUES



**BEGOOD  
SU - 0981**

9x E27 - MAX. 60W  
     
   230V.1.50Hz

*Jean Paul Narvesi*

 **preto mate / branco**  
 matte black / white  
 noir mat / blanc

mais acabamentos sob consulta . more finishes on request . plus finitions sur demande p. 255



**PLAFOND**  
PLAFOND . PLAFONNIER

ARTINOX PORTUGUESE LIGHTING SINCE 1977



**PLAFOND**  
PLAFOND . PLAFONNIER

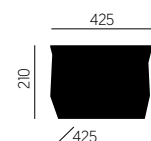

**AZORES SQUARE**  
**PF - 0598**

3x E27 - MAX. 60W  
IP44 CE 230V 1.50Hz

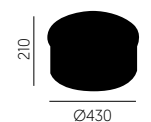

**AZORES ROUND**  
**PF - 0599**

3x E27 - MAX. 60W  
IP44 CE 230V 1.50Hz



 **níquel escovado**  
brushed nickel  
nickel brossé

mais acabamentos sob consulta . more finishes on request . plus finitions sur demande p. 255

 **chintz branco / chintz preto**  
white chintz / black chintz  
chintz blanc / chintz noir

consultar . check . consulter p. 251



**CANDEIROS DE MESA**  
TABLE LAMPS . LAMPES DE TABLE

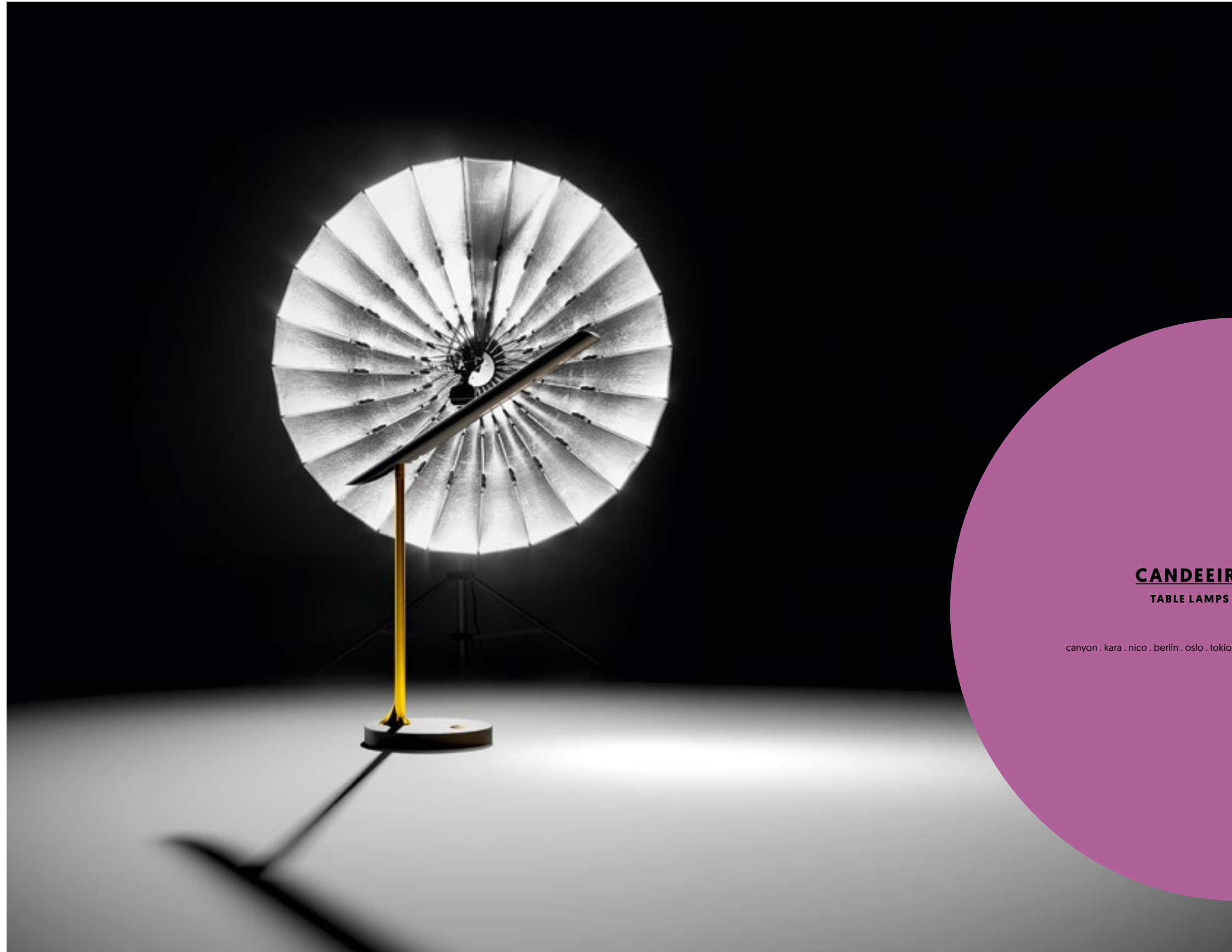

**CANDEIROS DE MESA**  
TABLE LAMPS . LAMPES DE TABLE

canyon . kara . nico . berlin . oslo . tokio . rivo . jar . mutene . crane . urban . bp65 . basel



## CANDEIROS DE MESA

TABLE LAMPS . LAMPES DE TABLE

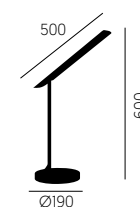
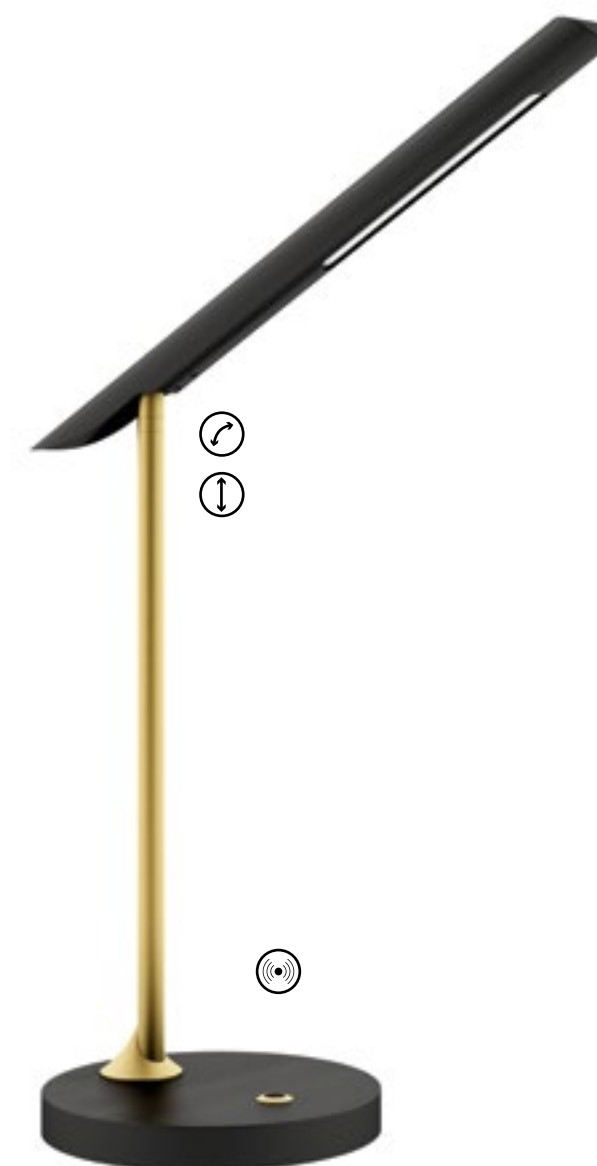
**CANYON**  
**CM - 0506**2x LED - MAX. 4,5W  
3000°K 540lm  
Driver included

320V 1.50Hz

**oxidado / preto mate**  
antique gold / matte black  
or antique / noir mat

**mais acabamentos sob consulta** . more finishes on request . plus finitions sur demande p. 255



## CANDEIROS DE MESA

TABLE LAMPS . LAMPES DE TABLE

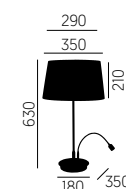
**KARA**  
**CM - 0428**1x E27 - MAX. 60W  
1x LED - MAX. 3W  
Driver included

320V/1.50Hz

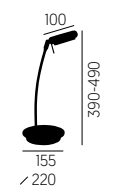
**níquel escovado**  
brushed nickel  
nickel brossé**pongée preto**  
black pongée  
pongée noir**NICO**  
**CM - 0441**

 1x GX53 - MAX. 9W  

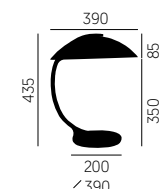
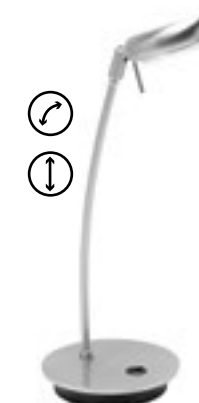
 320V/1.50Hz
**níquel escovado**  
brushed nickel  
nickel brossé**BERLIN**  
**CM - 0438**

 1x E27 - MAX. 60W  

 320V/1.50Hz
**níquel escovado**  
brushed nickel  
nickel brossé**vários**  
various  
diverse

mais acabamentos sob consulta . more finishes on request . plus finitions sur demande p. 255

**chintz preto**  
black chintz  
chintz noir

consultar . check . consulter p. 251

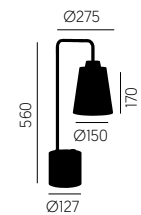

**OSLO**  
**CM - 0501**

1x E27 - MAX. 60W  
Dimmable light

IP20 CE 320V.150Hz

**preto mate / oxidado**  
matte black / antique gold  
noir mat / or antique

**chintz preto**  
black chintz  
chintz noir

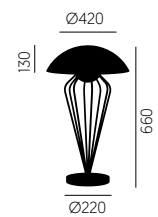

**TOKIO**  
**CM - 0502**

2x G9 - MAX. 25W

IP20 CE 320V.150Hz

**branco pintado / oxidado**  
painted white / antique gold  
blanc peint / or antique

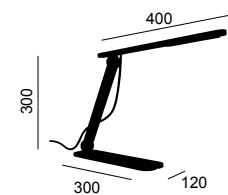

**RIVO**  
**CM - 0507**

2x LED MAX 4,5W  
3000°K 540lm  
Driver included

IP20 CE 320V.150Hz

**preto mate / cromado**  
matte black / chrome  
noir mat / chrome poli



## CANDEIROS DE MESA

TABLE LAMPS . LAMPES DE TABLE

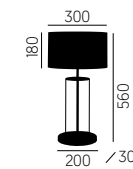

**JAR**  
**CM - 0444**

1x E27 - MAX. 60W  
3000°K 190lm

IP20 CE 320V.150Hz

**banho ouro**  
gold plate  
or

**chintz preto**  
black chintz  
chintz noir

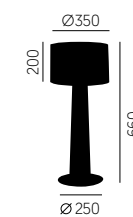

**MUTENE**  
**CM - 0460**

1x E27 - MAX. 60W

IP20 CE 320V.150Hz

**níquel escovado / m**  
brushed nickel / wood  
nickel brossé / bois n

**pongée branco**  
white pongée  
pongée blanc



mais acabamentos sob consulta . more finishes on request . plus finitions sur demande p. 255



mais acabamentos sob consulta . more finishes on request . plus finitions sur demande p. 255



consultar . check . consulter p. 251





## CANDEIROS DE MESA

TABLE LAMPS . LAMPES DE TABLE

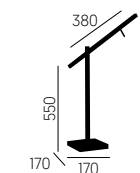
**CRANE**  
**CM - 0472**2x LED - MAX. 2,3W  
3000°K 270lm  
Driver included

320V 1.50Hz

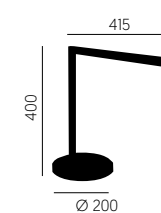
**CM - 0472**  
USB PORT - 5V**cromado**  
chrome  
chrome poli**URBAN**  
**CM - 0477**1x LED - MAX. 7 W  
3000°K 1095lm  
Driver included

320V 1.50Hz

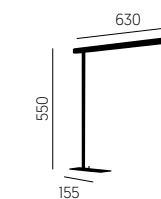
**cromado**  
chrome  
chrome poli**BP55**  
**CM - 0504**1x LED - MAX. 10W  
3000°K 480lm  
Driver included

320V 1.50Hz

**níquel escovado**  
brushed nickel  
nickel brossé*Jean Paul Narzisi***vários**  
various  
diverse

mais acabamentos sob consulta . more finishes on request . plus finitions sur demande p. 255







## CANDEIROS DE MESA

TABLE LAMPS . LAMPES DE TABLE

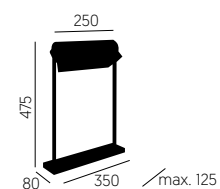
**BASEL**  
**CM - 0474**

1x LED - MAX. 3,6W  
3200°K 1080lm/mt  
Driver included

⊕ IP20 CE 230V 1.50Hz

**preto mate / latão polido.**  
matte black / polished brass  
noir mat / laiton poli

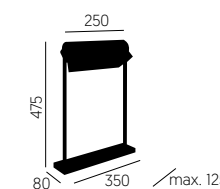
**BASEL**  
**CM - 0503**

1x LED - MAX. 3,6W  
3200°K 1080lm/mt  
Driver included

⊕ IP20 CE 230V 1.50Hz

**verde ral 6001 / preto mate / latão polido.**  
green ral 6001 / matte black / polished brass  
vert ral 6001 / noir mat / laiton poli

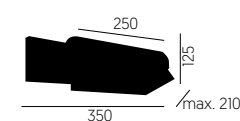
**BASEL**  
**AP - 1320**

LED - MAX. 3,6W  
3200°K 1080lm  
Driver included

⊕ IP20 CE 230V 1.50Hz

**preto mate / latão polido.**  
matte black / polished brass  
noir mat / laiton poli

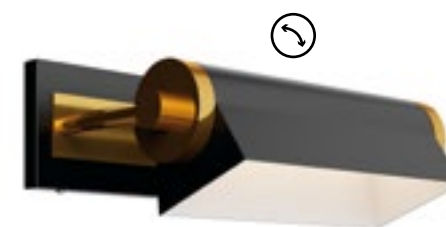

**mais acabamentos sob consulta .** more finishes on request . plus finitions sur demande p. 255

**CANDEEIROS DE PÉ**  
FLOOR LAMPS . LAMPADAIRES

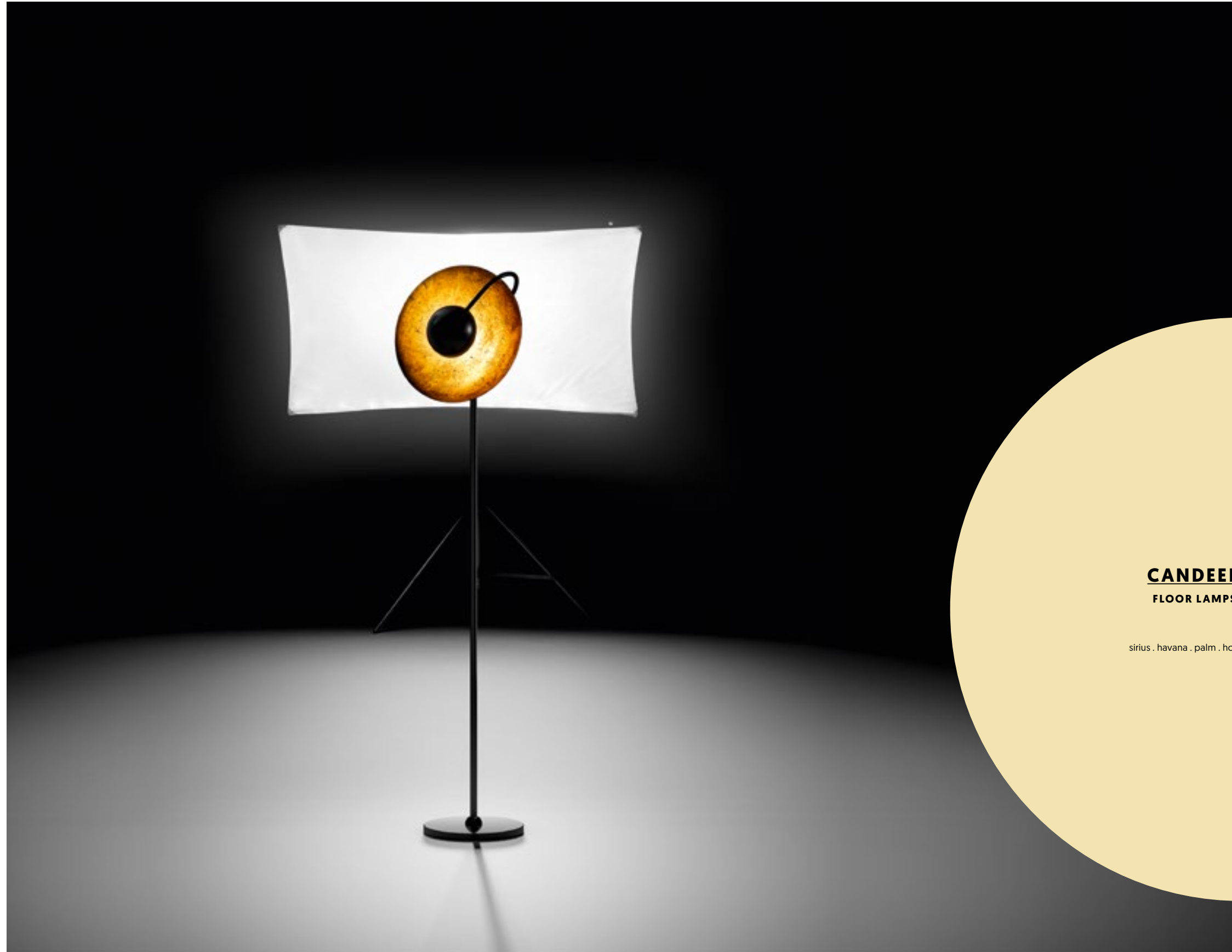

**CANDEEIROS DE PÉ**  
FLOOR LAMPS . LAMPADAIRES

sirius . havana . palm . home . mutene . poweel . artus



## CANDEEIROS DE PÉ

FLOOR LAMPS . LAMPADAIRES

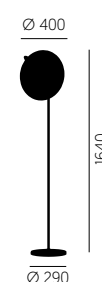
**SIRIUS**  
**CP - 1057**

1x LED - MAX. 8W  
3000°K 688lm  
Driver not included  
LED20 CE 230V/50Hz

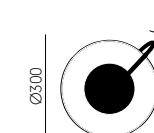
**SIRIUS**  
**AP - 1378**

1x LED - MAX. 8W  
3000°K 688lm  
Driver not included  
LED20 CE 230V/50Hz

**preto mate / oxidado**  
matte black / antique gold  
noir mat / or antique

 **folha de ouro / preto mate**  
golden leaf / matte black  
feuille d'or / noir mat

**mais acabamentos sob consulta** . more finishes on request . plus finitions sur demande p. 255



## CANDEEIROS DE PÉ

FLOOR LAMPS . LAMPADAIRES

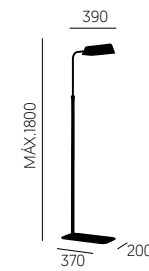

### HAVANA CP - 1058

1x E14 - MAX. 40W  
  230V 150Hz

 **cromado / preto mate**  
 chrome / matte black  
 chrome poli / noir mat

mais acabamentos sob consulta . more finishes on request . plus finitions sur demande p. 255



## CANDEEIROS DE PÉ

FLOOR LAMPS . LAMPADAIRES

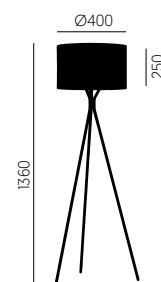

**PALM**  
**CP - 1059**

1x E27 - MAX. 60W  
  230V 150Hz

 **preto mate**  
matte black  
noir mat

**mais acabamentos sob consulta** . more finishes on request . plus finitions sur demande p. 255

 **pongée vermelho**  
red pongée  
pongée rouge

**consultar** . check . consulter p. 251



## CANDEIROS DE PÉ

FLOOR LAMPS . LAMPADAIRES

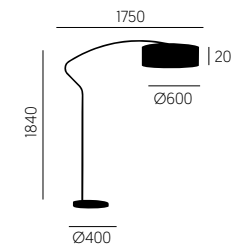

### HOME CP - 1048

1x E27 - MAX. 60W  
E27 CE 230V 1.50Hz

 **preto mate / cromado**  
matte black / chrome  
noir mat / chrome poli

mais acabamentos sob consulta . more finishes on request . plus finitions sur demande p. 255

 **chintz branco**  
white chintz  
chintz blanc

consultar . check . consulter p. 251



**CANDEIROS DE PÉ**  
FLOOR LAMPS . LAMPADAIRES

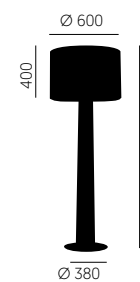

**MUTENE**  
**CP - 1022**

1x E27 - MAX. 60W  
IP20 CE 230V/150Hz

níquel escovado / madeira mutene  
brushed nickel / wood mutenye  
nickel brossé / bois mutenye

mais acabamentos sob consulta . more finishes on request . plus finitions sur demande p. 255

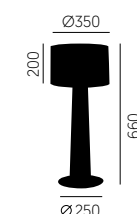

**MUTENE**  
**CM - 0460**

1x E27 - MAX. 60W  
IP20 CE 320V/150Hz

pongée branco  
white pongée  
pongée blanc

consultar . check . consulter p. 251





ARTINOX PORTUGUESE LIGHTING SINCE 1977

**CANDEEIROS DE PÉ**  
FLOOR LAMPS . LAMPADAIRES

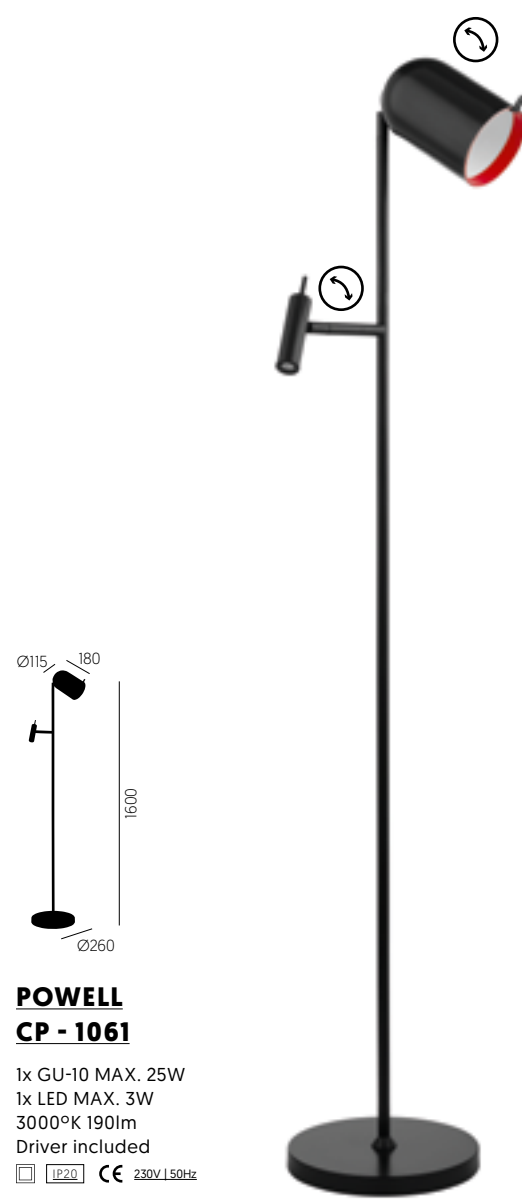

**POWELL**  
**CP - 1061**

1x GU-10 MAX. 25W  
1x LED MAX. 3W  
3000°K 190lm  
Driver included  
IP20 CE 230V 150Hz

Jean-Paul Narzisi

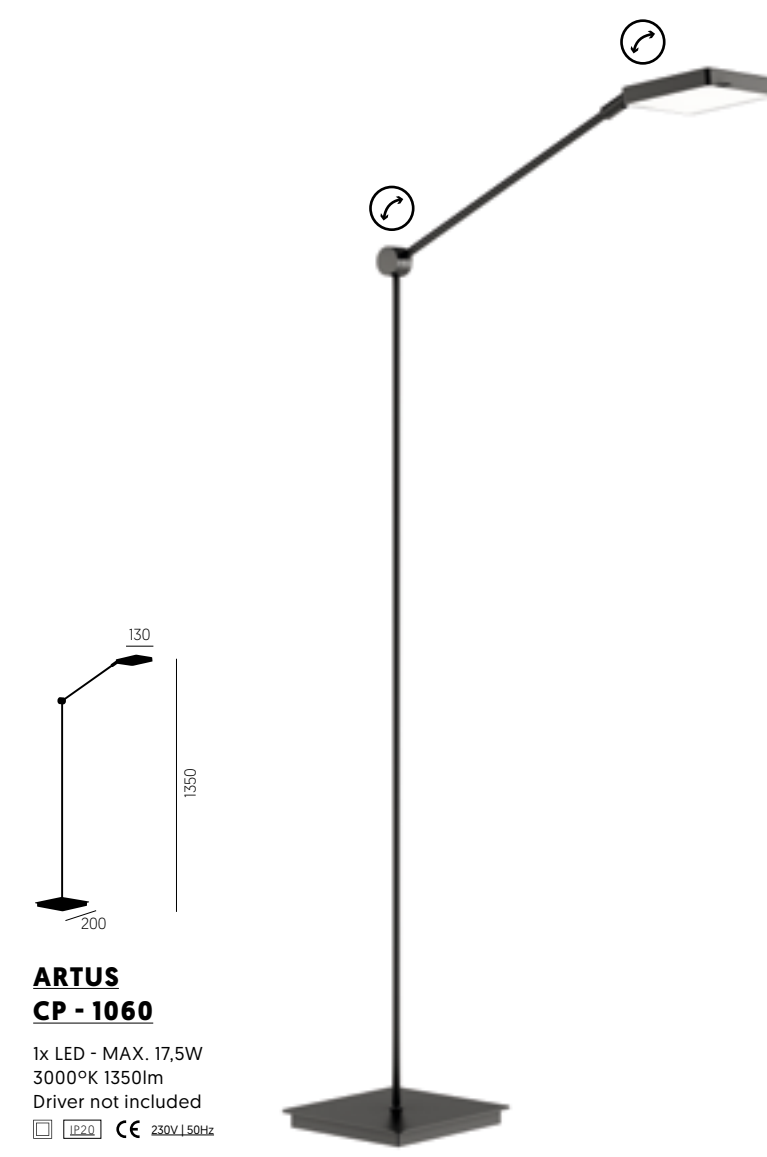

**ARTUS**  
**CP - 1060**

1x LED - MAX. 17,5W  
3000°K 1350lm  
Driver not included  
IP20 CE 230V 150Hz

Jean-Paul Narzisi

**preto mate**  
matte black  
noir mat

mais acabamentos sob consulta . more finishes on request . plus finitions sur demande p. 255





**CERÂMICA E VIDRO**  
CERAMIC AND GLASS . CÉRAMIQUE ET VERRE



**CERÂMICA E VIDRO**  
CERAMIC AND GLASS . CÉRAMIQUE ET VERRE

*cerâmica . ceramic . céramique  
orni*

*vidro . glass . verre  
big groove . small groove . night . mali*



## CERÂMICA

CERAMIC . CÉRAMIQUE

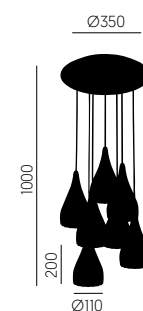

### ORNI SU - 0982

7x E27 - MAX. 60W  
 IP20  CE 230V / 150Hz

**níquel escovado / porcelana pintada a branco**  
 brushed nickel / white painted porcelain  
 nickel brossé / porcelaine peinte en blanc

 **vários**  
 various  
 diverse

mais acabamentos sob consulta . more finishes on request . plus finitions sur demande p. 255

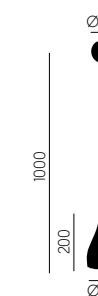

### ORNI SU - 0983

1x E27 - MAX. 60W  
 IP20  CE 230V / 150Hz

**preto mate / faiança pintada cinza**  
 matte black / ceramics painted in gray  
 noir mat / céramique peinte en gris



## CERÂMICA

CERAMIC . CÉRAMIQUE

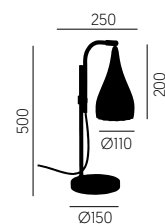

### ORNI CM - 0505

1x E27 - MAX. 60W  
  230V/150Hz



 **cromado / porcelana pintada a branco**  
 chrome / white painted porcelain  
 chrome poli / porcelaine peinte en blanc

**mais acabamentos sob consulta** . more finishes on request . plus finitions sur demande p. 255



**VIDRO**  
GLASS . VERRE

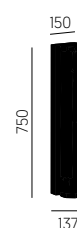

**BIG GROOVE**  
**AP - 1379**

3x E14 - MAX. 40W  
IP20 CE 230V/150Hz

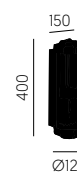

**SMALL GROOVE**  
**AP - 1380**

1x E14 - MAX. 40W  
IP20 CE 230V/150Hz



**oxidado**  
antique gold  
or antique

mais acabamentos sob consulta . more finishes on request . plus finitions sur demande p. 255





**VIDRO**  
GLASS . VERRE

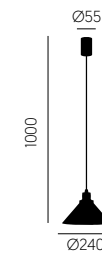

**NIGHT I**  
**SU - 0984**

1x E27 - MAX. 60W  
IP20 CE 230V / 50Hz

**oxidado**  
antique gold  
or antique

mais acabamentos sob consulta . more finishes on request . plus finitions sur demande p. 255

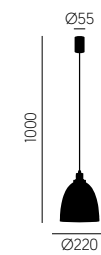

**NIGHT II**  
**SU - 0985**

1x E27 - MAX. 60W  
IP20 CE 230V / 50Hz

**vidro fumado preto**  
black smoked glass  
verre fumé noir

consultar . check . consulter p. 251



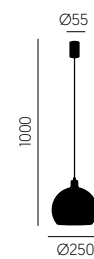

**NIGHT III**  
**SU - 0986**

1x E27 - MAX. 60W  
 230V 1.50Hz

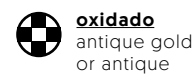
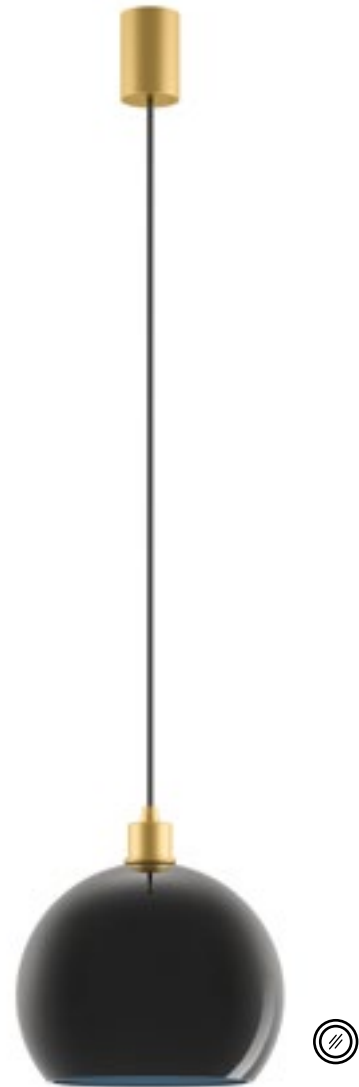

**oxidado**  
antique gold  
or antique

mais acabamentos sob consulta . more finishes on request . plus finitions sur demande p. 255

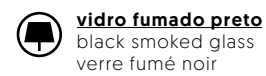

**vidro fumado preto**  
black smoked glass  
verre fumé noir

consultar . check . consulter p. 251

**VIDRO**  
GLASS . VERRE

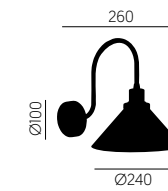

**NIGHT I**  
**AP - 1381**

1x E27 - MAX. 40W  
 230V 1.50Hz

**cromado**  
chrome  
chrome poli

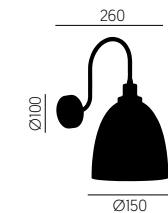

**NIGHT II**  
**AP - 1382**

1x E27 - MAX. 40W  
 230V 1.50Hz

**cobre mate**  
matte copper  
cuivre mat

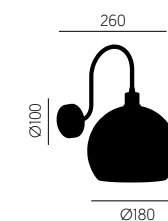

**NIGHT III**  
**AP - 1383**

1x E27 - MAX. 40W  
 230V 1.50Hz

**cobre brilhante**  
glossy copper  
cuivre brillant



**vários**  
various  
diverse

mais acabamentos sob consulta . more finishes on request . plus finitions sur demande p. 255

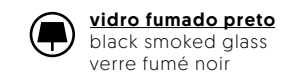

**vidro fumado preto**  
black smoked glass  
verre fumé noir

consultar . check . consulter p. 251



**VIDRO**  
GLASS . VERRE

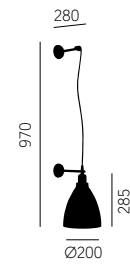

**MALI**  
**AP - 1384**

 1x E14 - MAX. 40W  
  230V/1.50Hz

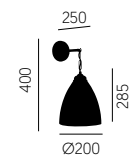

**MALI**  
**AP - 1385**

 1x E14 - MAX. 40W  
  230V/1.50Hz

 **oxidado**  
antique gold  
or antique

**mais acabamentos sob consulta** . more finishes on request . plus finitions sur demande p. 255

 **vidro canelado transparente**  
clear glass rods  
verre ondulé transparent

**consultar** . check . consulter p. 251



**DOWNLIGHTS & SPOTLIGHTS**

DOWNLIGHTS & SPOTLIGHTS . DOWNLIGHTS & SPOTLIGHTS

ARTINOX PORTUGUESE LIGHTING SINCE 1977

**RABIA ROUND TRIPLE**



**DOWNLIGHTS & SPOTLIGHTS**

DOWNLIGHTS & SPOTLIGHTS . DOWNLIGHTS & SPOTLIGHTS

spy . rabia . rabia round triple . zip ip65 . zip . cosmo . luan





**DOWNLIGHTS & SPOTLIGHTS**  
DOWNLIGHTS & SPOTLIGHTS . DOWNLIGHTS & SPOTLIGHTS

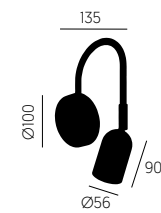

**SPY**  
**AP - 1386**

1x GU10 - MAX. 25W  
IP20 CE 320V 1.50Hz

**cinza ral 7016**  
grey ral 7016  
gris ral 7016

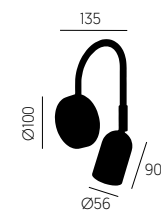

**SPY**  
**AP - 1386**

1x GU10 - MAX. 25W  
IP20 CE 320V 1.50Hz

**preto mate**  
matte black  
noir mat



 **vários**  
various  
diverse

mais acabamentos sob consulta . more finishes on request . plus finitions sur demande p. 255





## DOWNLIGHTS &amp; SPOTLIGHTS

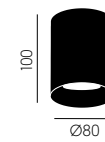

DOWNLIGHTS &amp; SPOTLIGHTS . DOWNLIGHTS &amp; SPOTLIGHTS

**RABIA  
PF - 0601**

1x GU10 - MAX. 50W  
  320V | 50Hz

**preto mate**  
 matte black  
 noir mat

**RABIA  
PF - 0601**

1x GU10 - MAX. 50W  
  320V | 50Hz

**branco mate**  
 matte white  
 blanc mat

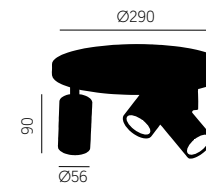
**RABIA ROUND TRIPLE  
PF - 0600**

3x GU10 - MAX. 25W  
  320V | 50Hz

**branco mate**  
 matte white  
 blanc mat



**mais acabamentos sob consulta** . more finishes on request . plus finitions sur demande p. 255

# ZIP IP65



## PF - 0602

**níquel escovado**  
brushed nickel  
nickel brossé

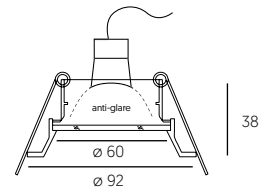

**Caraterísticas** . Caraterísticas . Caraterísticas

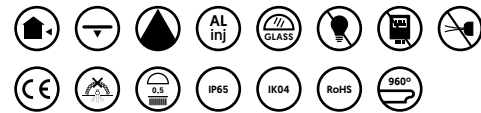

**Opções** . Options . Options



## PF - 0602 - PA

**níquel escovado**  
brushed nickel  
nickel brossé

**Compatível com** . Compatible with . Compatível avec



# DOWNLIGHTS & SPOTLIGHTS

DOWNLIGHTS & SPOTLIGHTS . DOWNLIGHTS & SPOTLIGHTS

# ZIP

ANTI-GLARE COMFORT



## PF - 0603

**cromado**  
chrome  
chrome poli

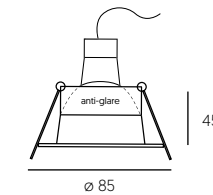

**Caraterísticas** . Caraterísticas . Caraterísticas

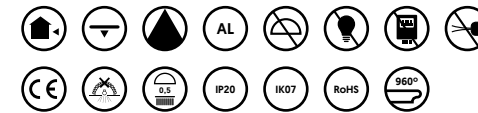

**Opções** . Options . Options



## PF - 0603 - PA

**cromado**  
chrome  
chrome poli

**Compatível com** . Compatible with . Compatível avec



# COSMO

24W 1800LM . 1900LM  
34W 2550LM . 2650LM



## PF - 0604

24W 100° 3000K 1800LM UGR<19  
24W 100° 4000K 1900LM UGR<19

**branco**  
white  
blanc

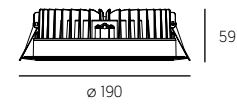

Caraterísticas . Caraterísticas . Caraterísticas

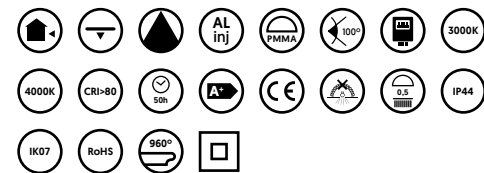

Opções . Options . Options



## PF - 0605

34W 100° 3000K 2550LM UGR<19  
34W 100° 4000K 2650LM UGR<19

**branco**  
white  
blanc

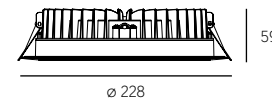

Fotometria . Photometry . Fotometria

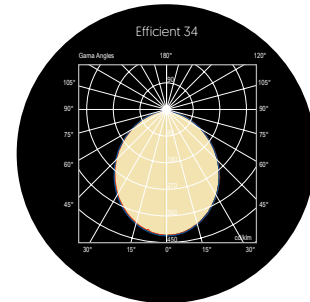

# DOWNLIGHTS & SPOTLIGHTS

DOWNLIGHTS & SPOTLIGHTS . DOWNLIGHTS & SPOTLIGHTS

# LUAN



## PF - 0606

**preto mate**  
matte black  
noir mat

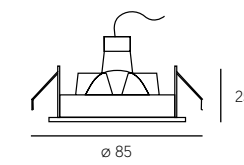

Caraterísticas . Caraterísticas . Caraterísticas

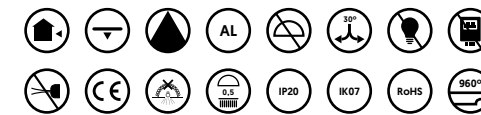

Opções . Options . Options



## PF - 0606 - PA

**preto mate**  
matte black  
noir mat

Compatível com . Compatible with . Compatible avec





**HERITAGE**  
HERITAGE . HERITAGE

ARTINOX PORTUGUESE LIGHTING SINCE 1977

**MING LANTERNS**

**HERITAGE**  
HERITAGE . HERITAGE

paul lanterns . ming lanterns . java two rounds . java one round . java . dutch . august

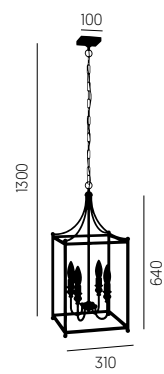

**PAUL LANTERNS**  
**SU - 0984**

4x E14 - MAX. 40W  
IP20 CE 230V 150Hz



**níquel escovado**  
brushed nickel  
nickel brossé

mais acabamentos sob consulta . more finishes on request . plus finitions sur demande p. 255

**HERITAGE**  
HERITAGE . HERITAGE

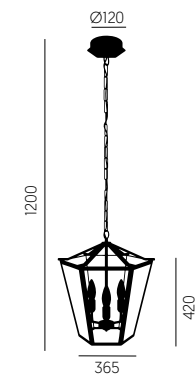

**MING LANTERNS**  
**SU - 0985**

3x E14 MAX. 40W  
IP20 CE 230V 150Hz



**oxidado mate**  
antique gold matte  
or antique mat

mais acabamentos sob consulta . more finishes on request . plus finitions sur demande p. 255



HERITAGE

HERITAGE . HERITAGE

ARTINOX PORTUGUESE LIGHTING SINCE 1974

**HERITAGE**  
HERITAGE . HERITAGE

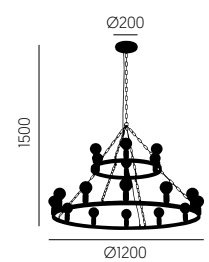
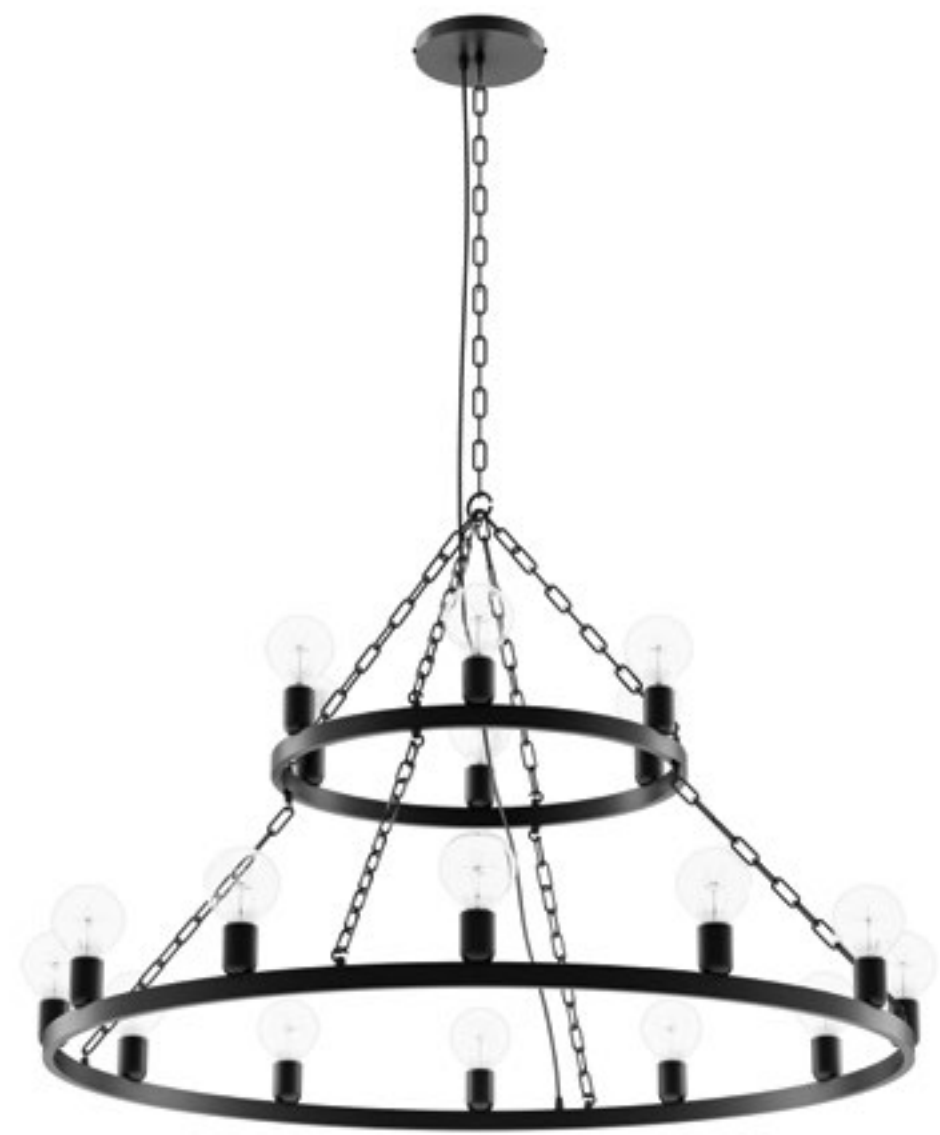

**JAVA Two Rounds**  
**SU - 0986/18**

12+6x E27 - MAX. 60W  
E27 CE 230V, 1.50Hz

**preto mate**  
matte black  
noir mat

mais acabamentos sob consulta . more finishes on request . plus finitions sur demande p. 255



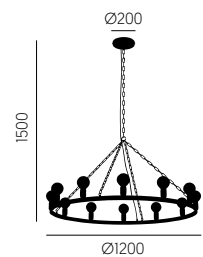
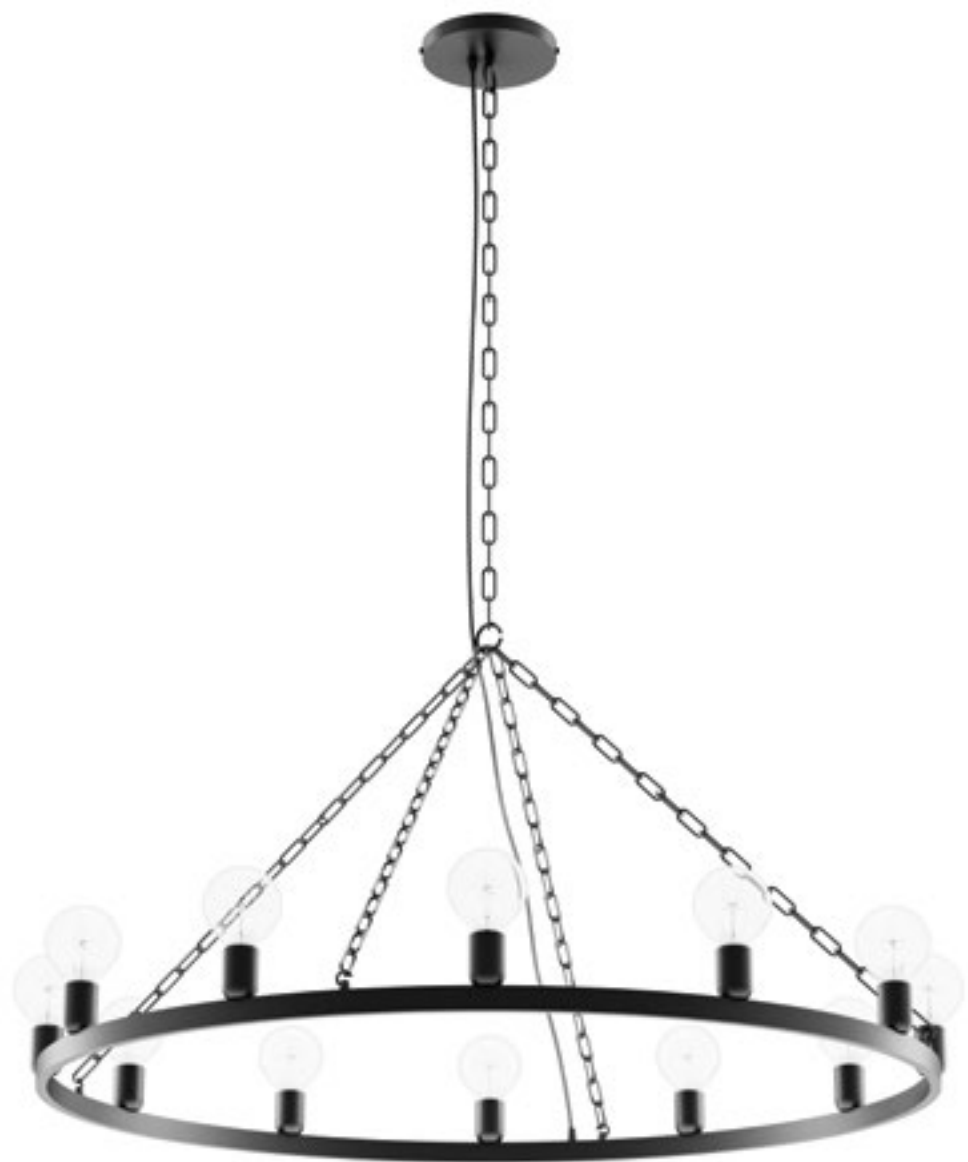

**JAVA One Round**  
**SU - 0986/12**

12x E27 - MAX. 60W  
IP20 CE 230V 150Hz

**preto mate**  
matte black  
noir mat

mais acabamentos sob consulta . more finishes on request . plus finitions sur demande p. 255

**HERITAGE**  
HERITAGE . HERITAGE

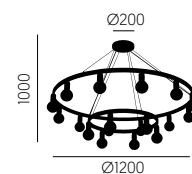

**JAVA Down Two Rounds**  
**SU - 0987**

12+6x E27 - MAX. 60W  
IP20 CE 230V 150Hz

**preto mate**  
matte black  
noir mat

mais acabamentos sob consulta . more finishes on request . plus finitions sur demande p. 255





**HERITAGE**  
HERITAGE . HERITAGE

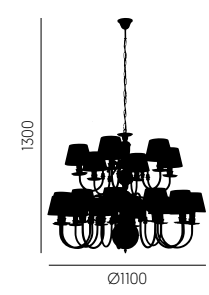

**DUTCH**  
**CT - 4168/18 OX**

12+6x E14 - MAX. 40W  
IP20 CE 230V.150Hz

**oxidado**  
antique gold  
or antique

mais acabamentos sob consulta . more finishes on request . plus finitions sur demande p. 255

**organza preto**  
black organza  
organza noir

consultar . check . consulter p. 251





HERITAGE

HERITAGE . HERITAGE

ARTINOX PORTUGUESE LIGHTING SINCE 1977

**HERITAGE**  
HERITAGE . HERITAGE

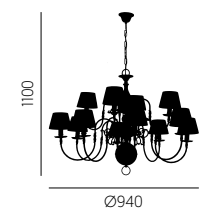

**DUTCH**  
**CT - 4216/12 OA**

8+4x E14 - MAX. 40W  
 230V.150Hz

**oxidado**  
antique gold  
or antique

mais acabamentos sob consulta . more finishes on request . plus finitions sur demande p. 255



**organza bege**  
beige organza  
organza beige

consultar . check . consulter p. 251





**DUTCH**  
**CT - 4049/9 OX**

6+3x E14 - MAX. 40W  
  230V 150Hz

 **oxidado**  
 antique gold  
 or antique

[mais acabamentos sob consulta](#) . more finishes on request . plus finitions sur demande p. 255

## HERITAGE

HERITAGE . HERITAGE



**DUTCH**  
**CT - 4169/6 OX**

6x E14 - MAX. 40W  
  230V 150Hz

 **oxidado / madeira mogno**  
 antique gold / mahogany wood  
 or antique / bois d'acajou

[mais acabamentos sob consulta](#) . more finishes on request . plus finitions sur demande p. 255

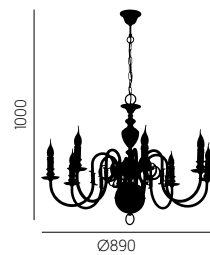

**DUTCH**  
**CT - 4168/8 OX**

8x E14 - MAX. 40W  
IP20 CE 230V 1.50Hz

**oxidado**  
antique gold  
or antique

mais acabamentos sob consulta . more finishes on request . plus finitions sur demande p. 255

**HERITAGE**  
HERITAGE . HERITAGE

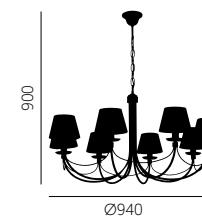

**AUGUST**  
**CT - 4214/8 O3**

8x E14 - MAX. 40W  
IP20 CE 230V 1.50Hz

**castanho ferrugem**  
brown rust  
rouille brune

mais acabamentos sob consulta . more finishes on request . plus finitions sur demande p. 255

**linho mostarda**  
linen mustard  
lin moutarde

consultar . check . consulter p. 251



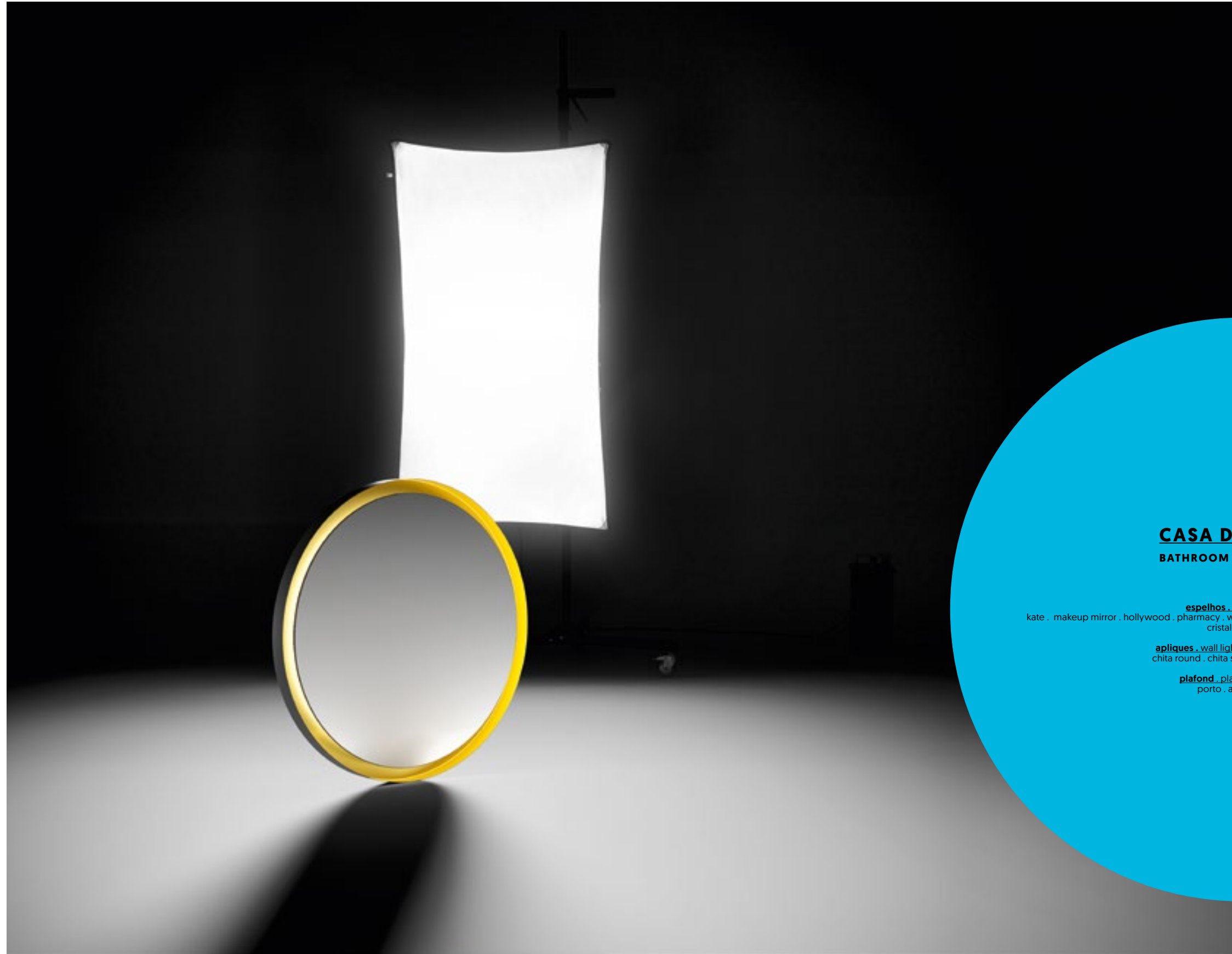

**CASA DE BANHO**  
BATHROOM . SALLE DE BAIN

**espelhos . mirrors . miroirs**  
kate . makeup mirror . hollywood . pharmacy . way . bass . koe . fair . juno . esperance . aqua . robert .  
cristal . ana . kris

**apliques . wall lights . appliques murales**  
chita round . chita square . galia . gulf . jara

**plafond . plafond . plafonnier**  
porto . aveiro . lisboa



**KATE**  
**ES - 0069**

1x LED - MAX. 7,2W  
5000°K 1100lm /mt  
Driver included  
IP44 CE 230V/150Hz

**preto mate / oxidado**  
matte black / antique gold  
noir mat / or antique

mais acabamentos sob consulta . more finishes on request . plus finitions sur demande p. 255

**ESPELHOS**  
MIRRORS . MIROIRS

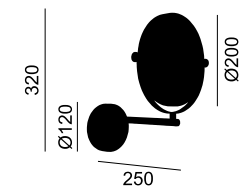

**MAKEUP MIRROR**  
**AP - 1394**  
Without electrification

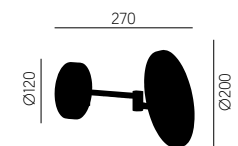

**MAKEUP MIRROR**  
**AP - 1395**

1x G9 - MAX. 25W  
IP44 CE 230V/150Hz



**cromado**  
chrome  
chrome poli

mais acabamentos sob consulta . more finishes on request . plus finitions sur demande p. 255



## ESPELHOS

MIRRORS . MIROIRS

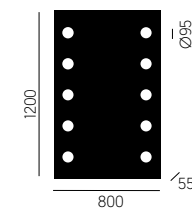

### HOLLYWOOD ES - 0070

10x E14 - MAX. 40W  
  230V 150Hz

 **branco brilhante pintado**  
 painted glossy white  
 blanc brillant peint

**mais acabamentos sob consulta** . more finishes on request . plus finitions sur demande p. 255



ESPELHOS  
MIRRORS . MIROIRS

ARTINOX PORTUGUESE LIGHTING SINCE 1977

## ESPELHOS

MIRRORS . MIROIRS

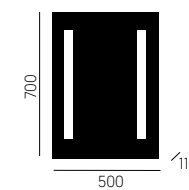

### PHARMACY

ES - 0071

2x T5 - MAX. 13W  
IP44 CE 230V 1.50Hz

 **moldura inox / branco**  
inox frame / white  
inox cadre / blanc

mais acabamentos sob consulta . more finishes on request . plus finitions sur demande p. 255





**ESPELHOS**  
MIRRORS . MIROIRS

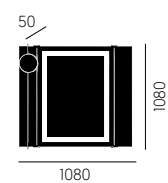

**WAY**  
**ES - 0062**

1x LED - MAX. 38W  
3200°K 1080lm/mt  
Driver included  
IP44 CE 230V 1.50Hz

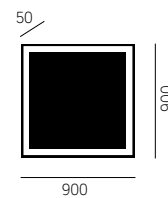

**BASS**  
**ES - 0061**

1x LED - MAX. 46W  
3200°K 1080lm/mt  
Driver included  
IP44 CE 230V 1.50Hz

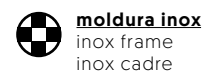
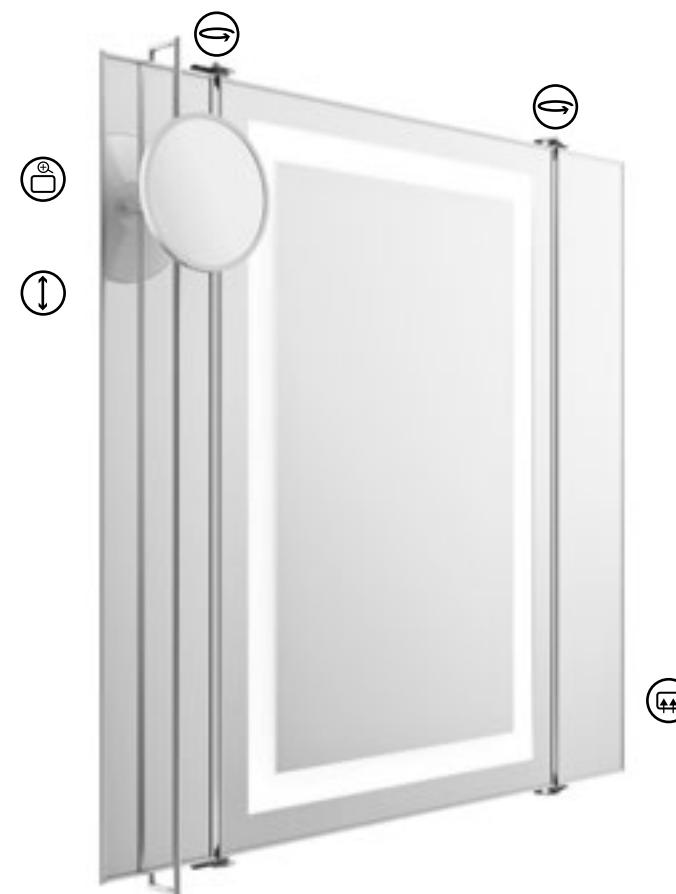

mais acabamentos sob consulta . more finishes on request . plus finitions sur demande p. 255





## ESPELHOS

MIRRORS . MIROIRS

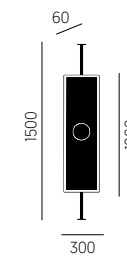

### KOE ES - 0063

1x LED - MAX. 17W  
3200°K 1080lm/mt  
Driver included

IP44 CE 230V.150Hz

 **moldura inox**  
inox frame  
inox cadre

mais acabamentos sob consulta . more finishes on request . plus finitions sur demande p. 255

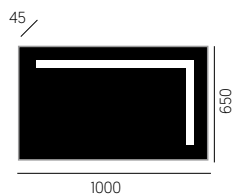

**FAIR**  
**ES - 0064**

1x LED - MAX. 20W  
3200°K 1080lm/mt  
Driver included

IP44 CE 230V 1.50Hz

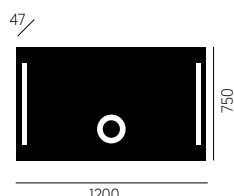

**JUNO**  
**ES - 0065**

2x T5 - MAX. 24W  
1x LED - MAX. 12W  
3200°K 1080lm/mt  
Driver included

IP44 CE 230V 1.50Hz

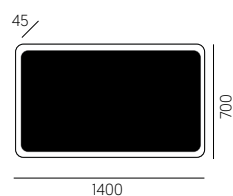

**ESPERANCE**  
**ES - 0067**

1x LED - MAX. 53W  
3200°K 1080lm/mt  
Driver included

IP44 CE 230V 1.50Hz

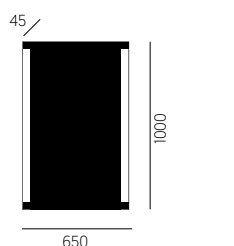

**AQUA**  
**ES - 0072**

1x LED - MAX. 27W  
3200°K 1080lm/mt  
Driver included

IP44 CE 230V 1.50Hz



vários  
various  
diverse

mais acabamentos sob consulta . more finishes on request . plus finitions sur demande p. 255

**ESPELHOS**  
MIRRORS . MIROIRS

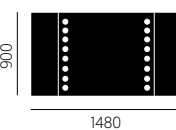
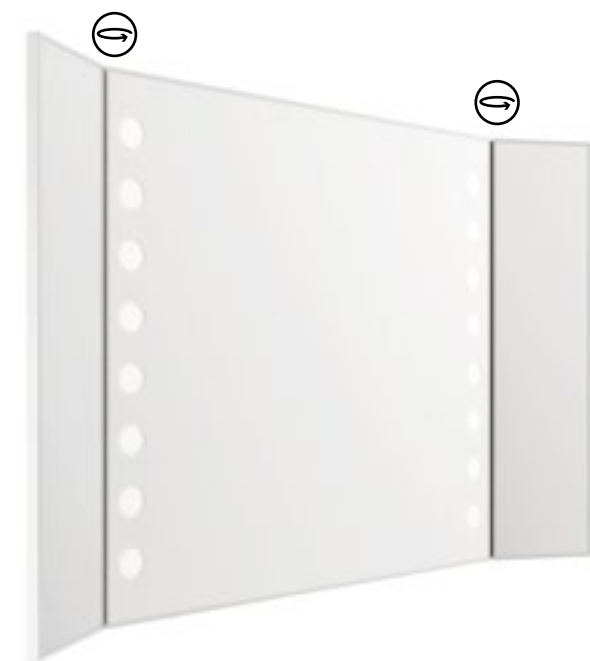

**ROBERT**  
**ES - 0073**

2x LED - MAX. 27W  
3000°K 1080lm  
Driver included

IP44 CE 230V 1.50Hz

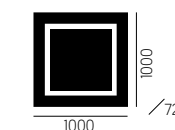

**CRISTAL**  
**ES - 0060**

1x TR5 - MAX. 60W  
3000°K 1080lm/mt

IP44 CE 230V 1.50Hz

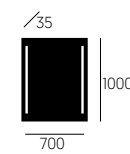

**ANA**  
**ES - 0045/07**

2x T5 - MAX. 21W

IP44 CE 230V 1.50Hz

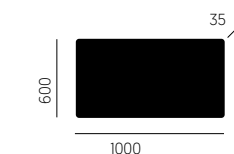

**KRIS**  
**ES - 0074**

1x LED - MAX. 37W  
3000°K 1080lm/mt  
Driver included

IP44 CE 230V 1.50Hz



vários  
various  
diverse

mais acabamentos sob consulta . more finishes on request . plus finitions sur demande p. 255

T5 LED optional in all models





## APLIQUES

WALL LIGHTS . APPLIQUES MURALES

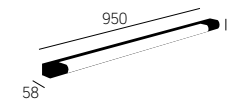
**CHITA ROUND**  
**AP - 1388**

1x T5 - MAX. 21W

 IP44  CE 230V 1.50Hz

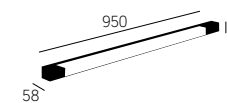
**cromado / difusor acrílico**  
 chrome / acrylic diffuser  
 chrome poli / diffuseur en acrylique
**CHITA SQUARE**  
**AP - 1389**

1x T5 - MAX. 21W

 IP44  CE 230V 1.50Hz

**cromado / difusor acrílico**  
 chrome / acrylic diffuser  
 chrome poli / diffuseur en acrylique

**vários**  
 various  
 diverse

**mais acabamentos sob consulta** . more finishes on request . plus finitions sur demande p. 255



**APLIQUES**  
 WALL LIGHTS . APPLIQUES MURALES

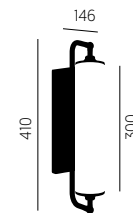

**GALIA**  
**AP - 1390**

 1X E27 - MAX. 60W  
  230V/150Hz

**cromado / difusor acrílico**  
 chrome / acrylic diffuser  
 chrome poli / diffuseur en acrylique

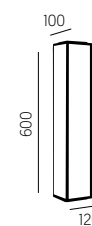

**GULF**  
**AP - 1391**

 1x T5 - MAX. 24W  
  230V/150Hz

**cromado / difusor acrílico**  
 chrome / acrylic diffuser  
 chrome poli / diffuseur en acrylique



 **cromado**  
 chrome  
 chrome poli

**mais acabamentos sob consulta** . more finishes on request . plus finitions sur demande p. 255



## APLIQUES

WALL LIGHTS . APPLIQUES MURALES

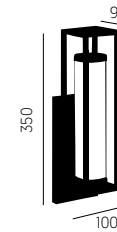
**JARA**  
**AP - 1392**

1X E14 - MAX. 40W  
  230V / 50Hz

**oxidado / difusor acrílico**  
 antique gold / acrylic diffuser  
 or antique / diffuseur en acrylique

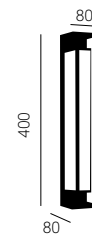
**JARA**  
**AP - 1393**

1x LED - MAX. 7W  
 3000°K 1095lm  
  230V / 50Hz

**oxidado / difusor acrílico**  
 antique gold / acrylic diffuser  
 or antique / diffuseur en acrylique



 **oxidado mate**  
 antique gold matte  
 or antique mat

**mais acabamentos sob consulta** . more finishes on request . plus finitions sur demande p. 255

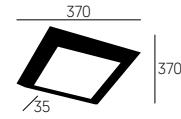

**PORTO**  
**PF - 0558**

1x TR5 - MAX. 22W  
IP44 CE 230V 150Hz

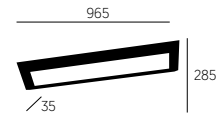

**PORTO**  
**PF - 0555**

2x T5 - MAX. 39W  
IP44 CE 230V 150Hz

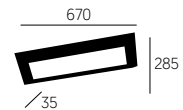

**PORTO**  
**PF - 0554**

2x T5 - MAX. 24W  
IP44 CE 230V 150Hz

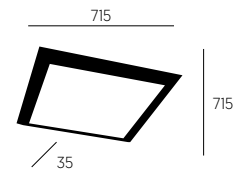

**PORTO**  
**PF - 0559**

4x T5 - MAX. 14W  
IP44 CE 230V 150Hz

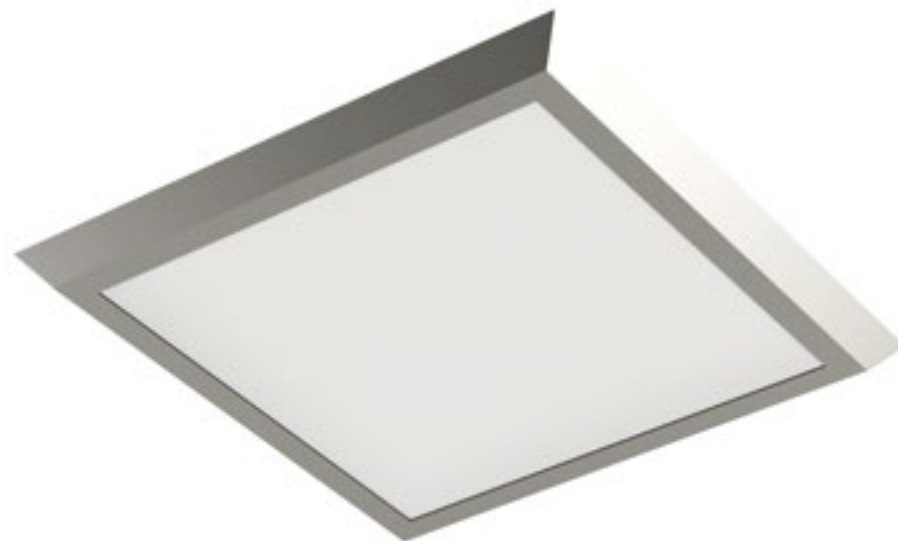

**níquel escovado mate / difusor acrílico fosco**  
matte brushed nickel / frosted acrylic diffuser  
nickel brossé mat / diffuseur en acrylique dépoli

mais acabamentos sob consulta . more finishes on request . plus finitions sur demande p. 255

**PLAFOND**

PLAFOND . PLAFONNIER

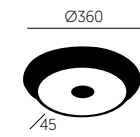

**AVEIRO**  
**PF - 0560**

1x TR5 - MAX. 22W  
IP44 CE 230V 150Hz

**cromado / difusor acrílico fosco**  
chrome / frosted acrylic diffuser  
chrome poli / diffuseur en acrylique dépoli



**AVEIRO**  
**PF - 0593**

2xE27 - MAX. 40W  
IP44 CE 230V 150Hz

**cromado / vidro transparente**  
chrome / transparent glass  
chrome poli / verre transparent

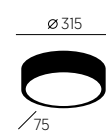

**AVEIRO**  
**PF - 0591**

2x E27 - MAX. 40W  
IP44 CE 230V 150Hz

**cromado / difusor acrílico fosco**  
chrome / frosted acrylic diffuser  
chrome poli / diffuseur en acrylique dépoli

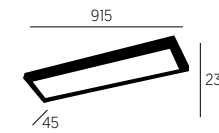

**LISBOA**  
**PF - 0567**

2x2 G11 - MAX. 36W  
IP44 CE 230V 150Hz

**níquel escovado / difusor acrílico fosco**  
brushed nickel / frosted acrylic diffuser  
nickel brossé / diffuseur en acrylique dépoli

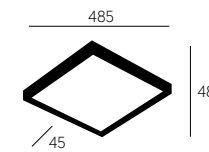

**LISBOA**  
**PF - 0565**

3x2 G11 - MAX. 36W  
IP44 CE 230V 150Hz

**níquel escovado / difusor acrílico fosco**  
brushed nickel / frosted acrylic diffuser  
nickel brossé / diffuseur en acrylique dépoli

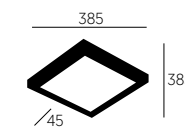

**LISBOA**  
**PF - 0564**

2x2 G11 - MAX. 24W  
IP44 CE 230V 150Hz

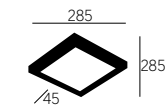

**LISBOA**  
**PF - 0563**

2x2 G11 - MAX. 18W  
IP44 CE 230V 150Hz

**difusor acrílico opalino**  
white acrylic diffuser  
diffuseur en acrylique blanc

mais acabamentos sob consulta . more finishes on request . plus finitions sur demande p. 255

**ABAJURES**  
SHADES . ABAT-JOUR

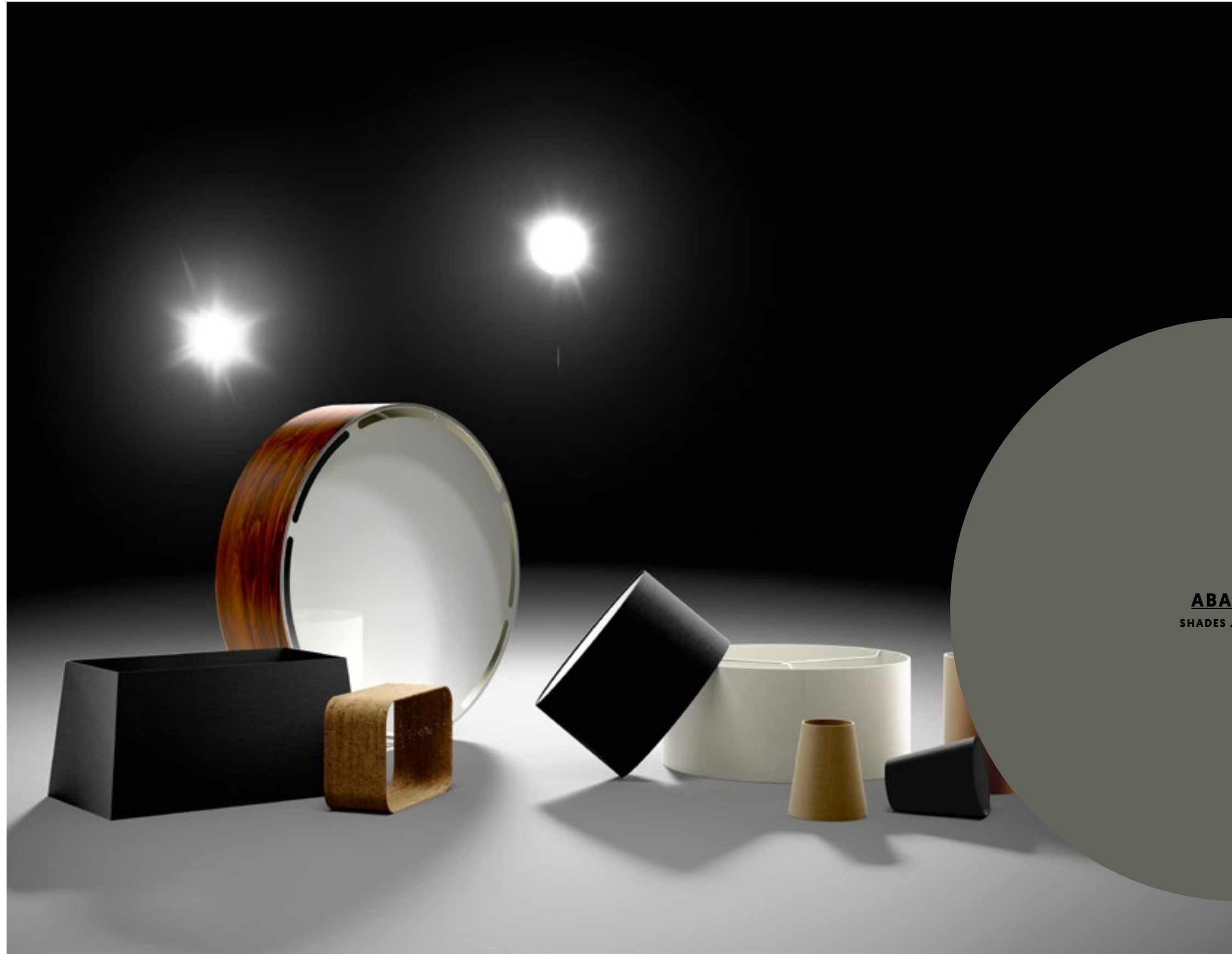



**MEDIDAS**  
MEASURES . MESURES



FORMA SHAPE MANIÈRE	MEDIDA MEASURE MESURER [CM] A x B x C	CHINTZ	CORTIÇA CORK LIÈGE	MADEIRA WOOD BOIS	COBRE COPPER CUIVRE	ORGANZA	RICHMOND	PONGÉE
	15 x 15 x 15 20 x 20 x 20 40 x 40 x 20 25 x 25 x 22 35 x 35 x 25 13 x 13 x 65	CQ151515B CQ202020B 1404020PB  CQ353525B CQ131365B						
	15 x 15 x 15 30 x 30 x 18 35 x 35 x 16 35 x 35 x 18 40 x 40 x 25 50 x 50 x 22 30 x 30 x 10 75 x 75 x 20 50 x 50 x 20 50 x 50 x 15 75 x 75 x 15 30 x 30 x 20 45 x 45 x 25 15 x 15 x 25 41 x 41 x 20 30 x 30 x 18 35 x 35 x 20 60 x 60 x 20 60 x 60 x 40 60 x 60 x 35	CR1515150 CR303018P CC3535162  1404025PB CC5050221  ARABCR6060201		MC303010P MC505015I MC505020P MC757515I MC7575200	PC303020C PC454525C		0151525RC	B0404025PG  C353520PB C606040PB
	16 x 10 x 20 20 x 17 x 15 25 x 20 x 15 44 x 35 x 23 12 x 06 x 15 15 x 10 x 17 35 x 29 x 21	CA201715B 0252015PB CA443523B 0120615PB CA151017P						0352922PP

**MEDIDAS**  
MEASURES . MESURES



FORMA SHAPE MANIÈRE	MEDIDA MEASURE MESURER [CM] A x B x C	CHINTZ	CORTIÇA CORK LIÈGE	MADEIRA WOOD BOIS	COBRE COPPER CUIVRE	ORGANZA	RICHMOND	PONGÉE
	20 x 12 x 16 23 x 15 x 20 30 x 20 x 22 40 x 25 x 25 30 x 20 x 15 30 x 10 x 18 45 x 30 x 20 50 x 35 x 15 50 x 35 x 20 110 x 35 x 25 30 x 15 x 20 40 x 20 x 25	0201216CE 0231520CE 0302022CE 0402525CE  PL301520P PL402023P						
	23 x 13 x 15 28 x 19 x 20 35 x 24 x 22	OB231315P OB281920P OB352422P						
	67 x 45 x 25 100 x 85 x 25					PC108525Z		0606025PD
	60 x 60 x 30	0606030PP						

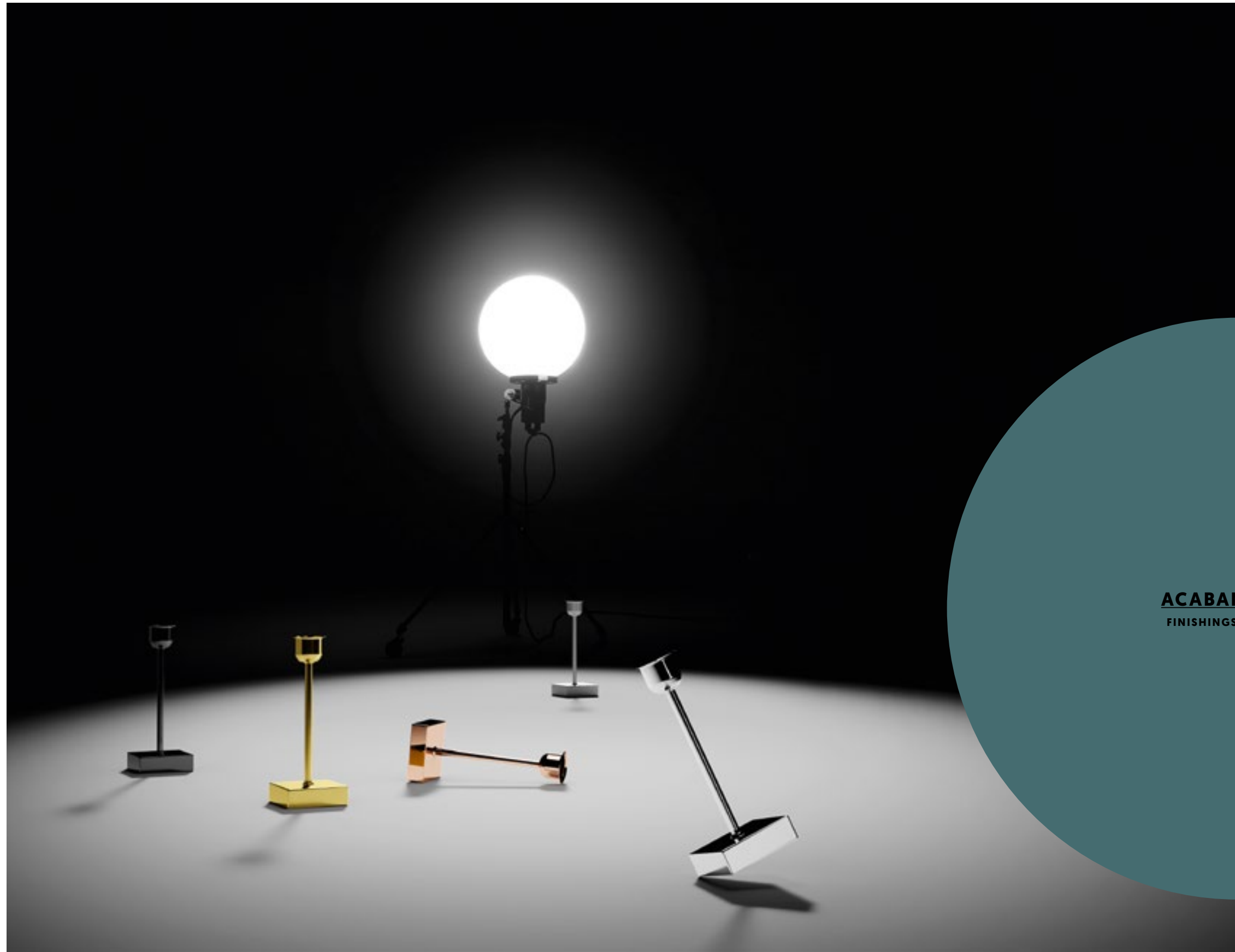

**ACABAMENTOS**  
FINISHINGS . FINITIONS

ARTINOX PORTUGUESE LIGHTING SINCE 1977



**ACABAMENTOS**  
FINISHINGS . FINITIONS

**ACABAMENTOS**

FINISHINGS . FINITIONS



**Aquando da encomenda, por favor indicar o código do acabamento pretendido.**  
when ordering, please indicate the finished code of finishing.  
lors de la commande, s'il vous plaît indiquer dans le code de finition prévue.

**Na ausência desta indicação, será fornecido o acabamento de acordo com o modelo apresentado.**  
in the absence of this indication, the finishing will be provided according to the model presented.  
en l'absence de cette déclaration, sera fourni avec l'accord de finition modèle présenté.

**exemplo** . example . exemple

**CM - 0484**    **NE**    \_\_\_\_\_    **código acabamento** . finishing code . la complétion de code

\_\_\_\_\_    **referência modelo** . model reference . modèle de référence

**ACABAMENTOS**

FINISHINGS . FINITIONS

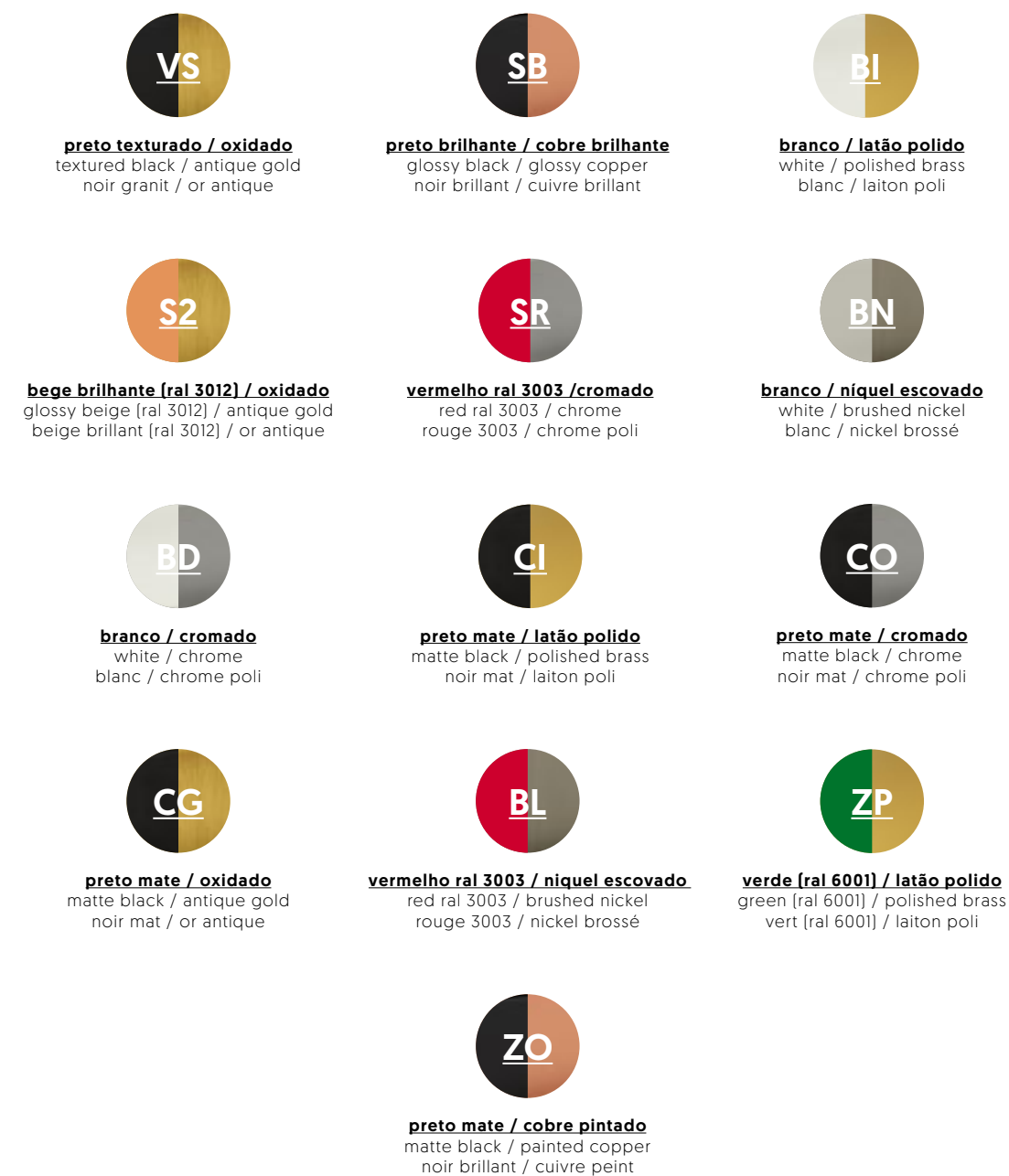



**INFO. TÉCNICA**  
 TECHNICAL INFO. . INFO. TECHNIQUE

## SIMBOLOGIA . SYMBOLOGY . SYMBOLOGIE

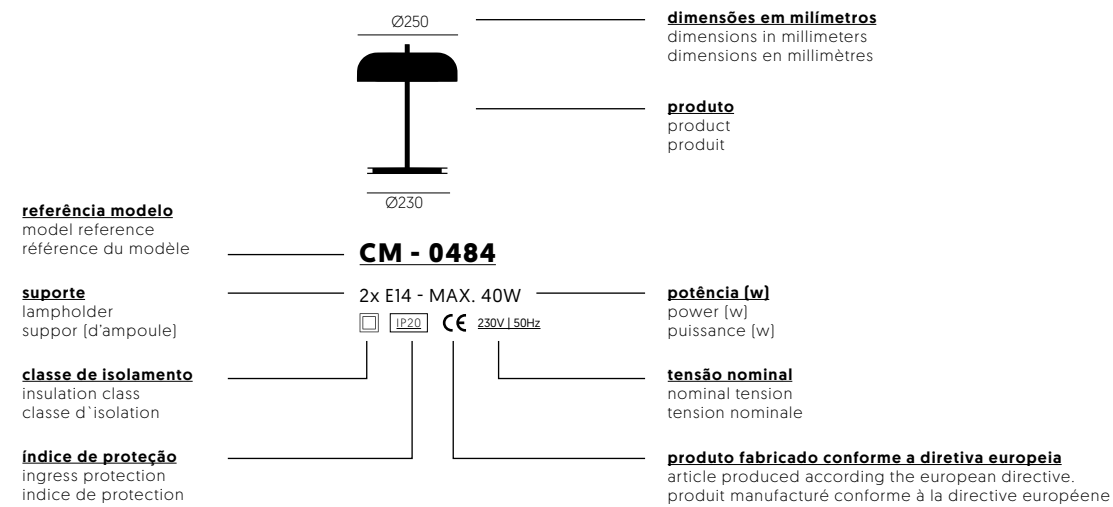

CE

230V | 50Hz

**Produto fabricado conforme a diretiva Europeia.**  
Product manufactured according to European directive.  
Produit fabriqué selon la directive européenne.

**Tensão nominal - todos os produtos estão concebidos para uma tensão de 230V-50Hz.**  
**É possível o fornecimento de versões para outras tensões/frequências, sob consulta.**

Rated voltage - All products are designed for a voltage of 230V-50Hz.  
It is possible to provide versions for other voltages / frequencies, on request.

Tension nominale - tous les produits sont conçus pour la tension 230V-50Hz.  
la fourniture de versions est possible pour d'autres tensions / fréquences sur demande.

## TERMINOLOGIA . TERMINOLOGY . TERMINOLOGIE

<b>AP</b>	<b>Aplique.</b> Wall light . Applique murale.
<b>CM</b>	<b>Candeeiro de mesa .</b> Table lamp . Lampe de table
<b>CP</b>	<b>Candeeiro de pé .</b> Floor lamp . Lampadaire
<b>SU</b>	<b>Suspensão .</b> Suspension . Suspension
<b>CT</b>	<b>Candeeiro de teto .</b> Ceiling lamp . Plafonnier
<b>ES</b>	<b>Espelho .</b> Mirror . Miroir
<b>PF</b>	<b>Plafond .</b> Plafond . Plafonnier

## ÍCONES . ICONS . ICÔNE

	<b>luminária para espaços interiores</b> luminary to use only indoors luminaire pour utilisation en intérieur		<b>dimável</b> dimmable dimmable
	<b>luminária de tecto com aplicação saliente</b> ceiling luminary with salient application luminaire de plafond avec montage en saillie		<b>sensor de movimento</b> motion sensor détecteur de mouvement
	<b>emissão simétrica da luz</b> symmetrical emission of the light émission symétrique		<b>luminária com interruptor on   off</b> luminary with on   off switch luminaire avec interrupteur on   off
	<b>orientação vertical em dois sentidos (graus)</b> vertical orientation in two directions [degrees] orientation verticale dans deux directions [degrés]		<b>desembaciador</b> demister pad anti-buée
	<b>ângulo de abertura da lente difusora (graus)</b> lens opening angle [degrees] angle d'ouverture de lentille [degrés]		<b>espelho de aumento</b> magnifying mirror miroir grossissant
	<b>alumínio</b> aluminium aluminium		<b>equipamento eléctrico não incluído</b> electrical equipment not included équipement électrique pas inclus
	<b>alumínio injectado</b> injected aluminium aluminium injecté		<b>suporte de lâmpada não incluído</b> holder not included douille non incluse
	<b>componente em vidro</b> glass component composant en verre		<b>lâmpada não incluída</b> lighting bulb not included ampoule non incluse
	<b>pintado</b> painted peint		<b>eficiência energética</b> energy efficiency efficacité énergétique
	<b>difusor em acrílico opalino</b> opal acrylic diffuser diffuseur en acrylique opale		<b>acabamento</b> finishing finition
	<b>difusor em vidro transparente</b> transparent glass diffuser diffuseur en verre transparent		<b>abajur</b> shade abat-jur
	<b>luminária sem difusor</b> luminary without diffuser luminaire sans diffuseur		<b>função ajuste vertical</b> vertical adjustment function fonction de réglage vertical
	<b>temperatura de cor do LED (kelvin)</b> LED's colour temperature [kelvin] température de couleur LED [kelvin]		<b>função ajuste horizontal</b> horizontal adjustment function fonction de réglage horizontal
	<b>temperatura de cor do LED (kelvin)</b> LED's colour temperature [kelvin] température de couleur LED [kelvin]		<b>função giratória 180°</b> rotational function 180° fonction de rotation 180°
	<b>tabela de cores</b> color table table de couleurs		<b>função giratória 360°</b> rotational function 360° fonction de rotation 360°
	<b>luz indireta</b> indirect light lumière indirecte		

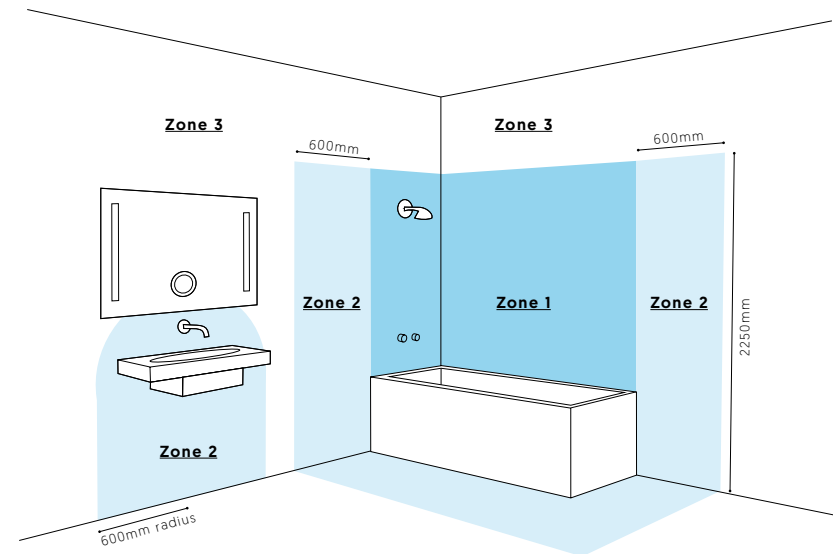
**ZONAS . ZONES . ZONES**

	<b>Zone 1</b> IP45 / IP55 / IP65
	<b>Zone 2</b> IP44 mínimo / at least / minimum
	<b>Zone 3</b> Sem requisitos especiais Without special requirements Aucune exigence particulière

**CLASSES DE ISOLAMENTO . INSULATION CLASSES . INSULATION CLASSES**

<b>Classe I</b>		<b>Luminária com isolamento básico com dispositivo de protecção d'eterra [ precisa de ser ligado à rede de terra].</b> Basic insulated luminaire with earth protective device (needs to be connected to the ground). Lampe avec une isolation de base avec dispositif de protection de la terre (doit être mise à la terre réseau).
<b>Classe II</b>		<b>Luminária com isolamento reforçado ou duplo, dispensando a ligação à terra.</b> Luminaire with reinforced or double insulation, without grounding. Lampe avec une isolation renforcée ou double, éliminant ainsi le sol.

**ÍNDICES DE PROTEÇÃO . INGRESS PROTECTION . INDICE DE PROTECTION**

<b>IP 20</b>	<b>Protegido contra penetração de corpos sólidos superiores a Ø12mm e sem proteção a líquidos.</b> Protected against solid objects over Ø12mm, without liquids protection. Protégé contre les corps solides supérieurs à 12mm, non protégé contre les liquides.
<b>IP 40</b>	<b>Protegido contra penetração de corpos sólidos superiores a Ø1mm e sem proteção a líquidos.</b> Protected against solid objects over Ø1mm, without liquids protection. Protégé contre les corps solides supérieurs à 1mm, non protégé contre les liquides.
<b>IP 44</b>	<b>Protegido contra penetração de corpos sólidos superiores a Ø1mm e com proteção contra projeção de água em todas as direções.</b> Protected against solid objects over Ø1mm and against splashing water from any direction. Protégé contre la pénétration de corps solides sur Ø1mm et protégé contre les projections d'eau de toutes les directions.
<b>IP 65</b>	<b>Estanque à penetração de poeiras e contra jatos de água.</b> Waterlight to the penetration of dust and against spurts of water. Totalment protégé contre les poussinères. Protégé contre les jets d'eau de toutes directions à la lance.

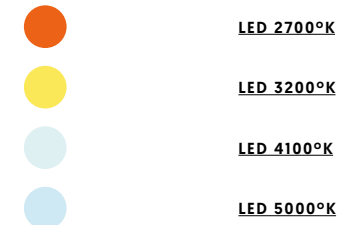
**COR DA LUZ . LIGHT COLOUR . COULEUR DE LA LUMIÈRE**

LED 2700°K

LED 3200°K

LED 4100°K

LED 5000°K

**CARACTERÍSTICAS TÉCNICAS DA LÂMPADA**TECHNICAL INFORMATION ON LAMPS  
INFORMATIONS TECHNIQUES SUR LES AMPOULES

LÂMPADA LIGHTBULB AMPOULE	SUPORTE LAMPHOLDER DOUILLE	POTÊNCIA [W] POWER [W] PUISSANCE
	E14	Máx. 40 W
	E27	Máx. 60 W
	G9	Máx. 25 W
	GU10	Máx. 50 W
	T5	Máx. 39 W
	LED	Máx. 1 W
	LED	Máx. 3 W

**medidas em milímetros . measured in millimeters . mesurée en millimètres.****Com o objectivo de aperfeiçoamento contínuo, a Artinnox reserva-se no direito de proceder a alteração nos modelos apresentados neste catálogo, sem aviso prévio. Todos os produtos Artinnox poderão ser personalizados, sob consulta.**

For the purpose of continuous improvement, Artinnox reserves the right to make changes to the models presented in this catalog, without prior notice. All Artinnox products can be customized on request.

Dans le but de l'amélioration continue, ARTINOX se réserve le droit d'apporter des modifications aux modèles de ce catalogue sans préavis. Tous les produits ARTINOX peuvent être personnalisés sur demande.

**As cores e dimensões das peças são meramente indicativas. Os produtos fotografados podem não corresponder exatamente ao produto final devido ao conceito gráfico do catálogo.**

The product colours and dimensions are merely indicative. The photographed products may not correspond exactly to the final product, due to the catalogue graphic concept.

Les couleurs et dimensions des produits sont simplement indicatives. Les produits photographiés peuvent ne pas correspondre exactement au produit final en raison du concept graphique du catalogue sous réserve de disponibilité.

  
www.viriato.com.pt

**artinox**<sup>®</sup>  
PORTUGUESE LIGHTING SINCE 1977

**Rua Fonte Moura, 227  
Vale do Grou, Apartado 12  
3754-908 Aguada de Cima  
Águeda Sul, Portugal**

**GPS N40°31' 41" / W8°26' 41"**

**T. +351 234 660 980  
F. +351 234 660 989**

**comercial@artinox.pt  
www.artinox.pt**

Cofinaciado por:







artinox®